



AVANTAGE

Italian Design 

Professional Cleaning Equipment

CLEANING

SANITÀ - HEALTH

HOTEL

Catalogo Generale
General Catalogue



Catalogo Generale
General Catalogue



The image shows a large, stylized white 'V' logo in the upper center, with horizontal white bars on either side. Below this, the VDM logo is visible on the facade of a building. The logo consists of a stylized 'V' inside a circle, followed by the letters 'VDM' in a bold, sans-serif font.

MISSION

L'AFFIDABILITÀ È UNO DEI VALORI CHE GUIDA LA NOSTRA MISSIONE.

I NOSTRI PRODOTTI E I NOSTRI SERVIZI SONO IL RISULTATO DI COMPETENZA E PASSIONE.

IL NOSTRO LAVORO È STRUTTURATO E ORGANIZZATO, MA PER NULLA RIGIDO: QUESTO PER DARE SEMPRE AI NOSTRI CLIENTI RISPOSTE CERTE E RAPIDE.

ELEGGENDO LA FLESSIBILITÀ COME NOSTRO PUNTO DI RIFERIMENTO, VOGLIAMO ESSERE UN SOGGETTO DI PRIMARIA IMPORTANZA NEL MERCATO DEL CLEANING PROFESSIONALE E CONTRIBUIRE IN MODO DECISIVO AL SUO SVILUPPO.

RELIABILITY IS ONE OF THE LEADING VALUES OF OUR MISSION.

OUR PRODUCTS AND OUR SERVICES ARE THE RESULT OF COMPETENCE AND PASSION.

OUR WORKING SYSTEM IS STRUCTURED AND ORGANISED BUT ABSOLUTELY NOT RIGID IN ORDER TO GIVE PROMPT AND PRECISE ANSWERS TO OUR CUSTOMERS.

BY ELECTING FLEXIBILITY AS OUR POINT OF REFERENCE WE WANT TO BE A COMPANY OF PRIMARY IMPORTANCE IN THE PROFESSIONAL CLEANING MARKET AND WE WANT TO CONTRIBUTE IN A DECISIVE WAY TO ITS DEVELOPMENT.

CLEANING

CARRELLI STRIZZATORI 06-15
MOP TROLLEYS

CARRELLI LINEA RACCOLTA 16-21
COLLECTING LINE

CARRELLI MULTIUSO 22-49
SERVICE CARS

STRIZZATORI 50-53
WRINGERS

SECCHI E COMPONENTI IN PLASTICA 54-59
BUCKETS AND PLASTIC COMPONENTS

TELAI E FRANGE PER USO A SECCO 60-65
DUST FLAT MOPS AND FRAMES

TELAI E FRANGE PER LAVARE 66-71
WET FLAT MOPS AND FRAMES

MOP IN COTONE E TNT 72-75
KENTUCKY MOPS

PRODOTTI VARI AD USO PROFESSIONALE 76-83
MISCELLANEOUS

PRODOTTI AD USO SEMI-PROFESSIONALE 84-89
SEMI-PROFESSIONALS PRODUCTS

SANITÀ - HEALTH

CARRELLI PER USO OSPEDALIERO 90-95
MULTIFUNCTIONAL CARS FOR HOSPITALS

ATTREZZATURE PER AMBIENTI SANITARI 96-99
EQUIPMENTS FOR SANITARY ENVIROMENTS



HOTEL LINE

LINEA CLASSIC
CLASSIC LINE

100-108

LINEA INNOVATIVE
INNOVATIVE LINE

109-121

LINEA ELBA
ELBA LINE

122-123

INDICE/*INDEX*

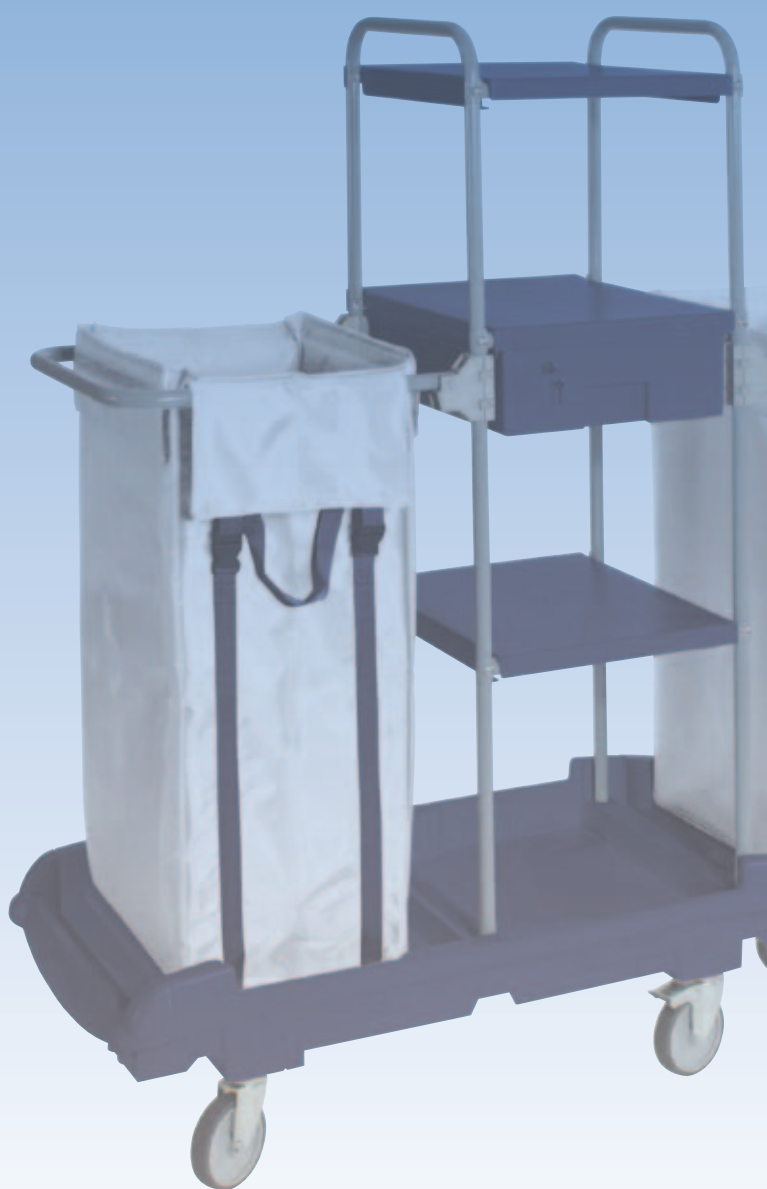



Carrelli strizzatore ***Mop Trolleys***

Una vasta gamma di carrelli strizzatore a uno e due secchi disponibili in 4 diverse tipologie di materiali: plastica - acciaio cromato - acciaio rivestimento rilsan - acciaio inox (AISI 304)

*A wide range of single and duo mop trolleys available in 4 different materials:
plastic - chromium plated steel - rilsan protected steel - stainless steel (AISI 304)*



Plastica/*Plastic*



Acciaio Rilsan/*Rilsan protected steel*

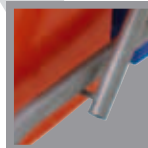

Acciaio cromato/*Chromium plated steel*



Acciaio inox/*Stainless steel*

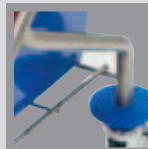



MAC 50 R
cm 40 x 35 x 75 h



MAC 80 A
cm 40 x 35 x 80 h



Brevettato
Patented 

ALEX 1 A
cm 52 x 40 x 82 h



ALEX 2 R
cm 52 x 40 x 82 h



CLEANING - Carrelli strizzatore
CLEANING - Mop Trolleys



Applicazioni
How to use



Brevettato
Patented



ALEX COMBI

cm 52 x 40 x 55 h



ALEX COMBI

Applicazioni
How to use



CLEANING - Carrelli strizzatore
CLEANING - Mop Trolleys



SKY 1.15
SKY 1.25
cm 55 x 46 x 88 h



SKY 1.15 MP
SKY 1.25 MP
cm 55 x 46 x 88 h



SKY 1.15 MP
SKY 1.25 MP
+ 23020R

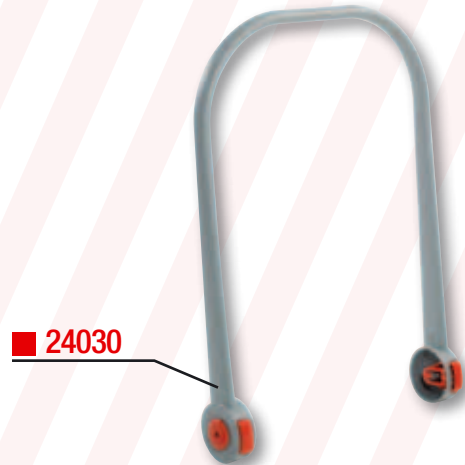

24030



Applicazioni
How to use



SE 1.15.80
SE 1.25.80
cm 48 x 38 x 90 h



EC 1.15.80
EC 1.25.80
cm 48 x 38 x 90 h

CLEANING - Carrelli strizzatore a un secchio
CLEANING - Single Mop Trolley



SA 1.15.80
SA 1.25.80
cm 48 x 38 x 90 h



SA/R 1.15.80
SA/R 1.25.80
cm 48 x 38 x 90 h



Acciaio Rilsan
Rilsan protected steel



3502 ■

3503 ■



CP 2600
cm 40 x 39 x 40 h

optional
Art. 1203 ■

optional
Art. 1510 ■



SJ 1.15.80
SJ 1.25.80
cm 48 x 38 x 96 h



MINIMAX 1
cm 55 x 45 x 97 h

CLEANING - Carrelli strizzatore a un secchio
CLEANING - Single Mop Trolley



SKY 2.15
SKY 2.25
cm 70 x 46 x 88 h



SKY 2.15 MP
SKY 2.25 MP
cm 70 x 46 x 88 h

■ 1350 EUR

■ 3501

■ 20060GR



SKY 2.15 MP
SKY 2.25 MP

Applicazioni
How to use



PL 2.15.80
cm 62 x 42 x 80 h



PLM 2.15.80
cm 62 x 42 x 84 h



CLEANING - Carrelli strizzatore doppio secchio
CLEANING - Duo Mop Trolleys



SA 2.15.80
SA 2.25.80
cm 65 x 42 x 80 h



SA/R 2.15.80
SA/R 2.25.80
cm 65 x 42 x 80 h



Acciaio Rilsan
Rilsan protected steel



EC 2.15.80
EC 2.25.80
cm 65 x 42 x 81 h



EUROPE 15
EUROPE 25
cm 65 x 42 x 81 h



Acciaio Rilsan
Rilsan protected steel



CLEANING - Carrelli strizzatore doppio secchio
CLEANING - Duo Mop Trolleys



SE 2.15.80
SE 2.25.80
cm 65 x 34 x 86 h



SE 2.15.80/M
SE 2.25.80/M
cm 65 x 42 x 88 h



SEG 2.15.80
SEG 2.25.80
cm 65 x 42 x 88 h



L 2.15.80
L 2.25.80
cm 66 x 43 x 88 h



Pressa girevole
Rotating wringer
L 2.15.80
L 2.25.80



Applicazioni
How to use



CLEANING - Carrelli strizzatore doppio secchio
CLEANING - Duo Mop Trolleys



E 2.15.80
E 2.25.80
cm 65 x 42 x 88 h



EMF 2.15.80
EMF 2.25.80
cm 65 x 42 x 90 h



P 2.15.80
P 2.25.80
cm 84 x 51 x 82 h



BIOSTEEL P15
BIOSTEEL P25
cm 84 x 51 x 82 h

Acciaio Inox (AISI 304)
Stainless steel (AISI 304)



CARRELLO PIEGHEVOLE
FOLDING TROLLEY

P 2.15.80
P 2.25.80
Biosteel P15/25

Applicazioni
How to use



CLEANING - Carrelli strizzatore doppio secchio
CLEANING - Duo Mop Trolleys



Carrelli linea raccolta
Collecting line

Una linea di carrelli - da 1 a 4 sacchi
- per la raccolta differenziata dei
rifiuti

*A line of trolleys - from 1 to 4 bags -
for selective waste collection*



Carrello pieghevole/*X-CAR*

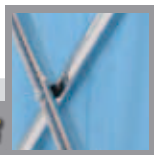

Carrello a due sacchi/*Double bag service car*

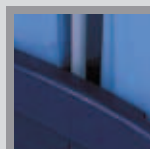



L 1.50.80 PED
cm 50 x 44 x 102 h



HE (pieghevole)
HE (folding)
cm 55 x 52 x 93 h



L 1.50.80
cm 50 x 44 x 102 h



SA/X
cm 53 x 50 x 104 h

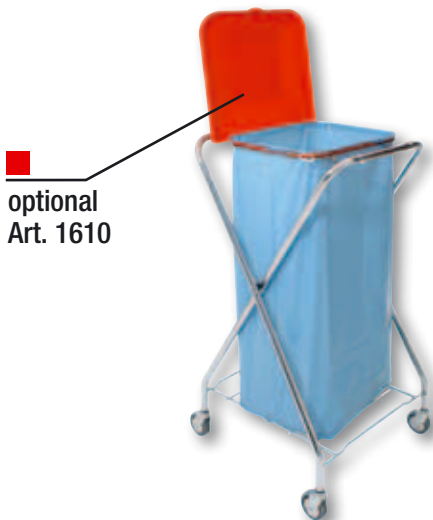

optional
Art. 1610



SA/XT
cm 53 x 50 x 104 h



X 2.50.80
cm 53 x 50 x 104 h

CLEANING - Carrelli linea raccolta
CLEANING - Collecting line

optional
■ Art. 1667



optional
Art. 1730 ■

XE 2.50.80

cm 53 x 50 x 101 h



L 2.90.100

cm 90 x 44x 105h



L 2.115.100

cm 115 x 44 x 105h



LSC 2.125.100

cm 125 x 44x 105h



H 5006

cm 110 x 60x 105h



BIOSTEEL X

cm 53 x 50 x 104h



CLEANING - Carrelli linea raccolta
CLEANING - Collecting line



L 1.75.80 - 2 S
cm 75 x 44 x 103 h



JOKER TRIO
cm 115 x 50 x 106 h



IDEABASE 2
cm 83 x 52 x 105 h



IDEABASE 3
cm 83 x 52 x 105 h



CLEANING - Carrelli linea raccolta
CLEANING - Collecting line



MX 400
cm 110 x 56 x 105 h



MX 401
cm 110 x 56 x 105 h



MX 402
cm 110 x 56 x 105 h



MX 403
cm 110 x 56 x 105 h



Riciclabile
Recyclable



Montaggio veloce
Quick assembly



Anti ruggine
Rustproof



Conforme
Compliance

CLEANING - Carrelli linea raccolta
CLEANING - Collecting line



Carrelli linea multiuso
Service Cars

La più importante linea di carrelli multifunzione di varie dimensioni con diverse capacità di carico.

The most impressive line of multifunctional cars of various sizes with different loading capacity. Available in four different materials.



Riciclabile
Recyclable



Montaggio veloce
Quick assembly



Anti ruggine
Rustproof



Conforme
Compliance



Plastica/*Plastic*



Riciclabile
Recyclable



Montaggio veloce
Quick assembly



Anti ruggine
Rustproof



Conforme
Compliance



Plastica e Acciaio Rilsan
Plastic and Rilsan protected steel



Acciaio cromato/*Chromium plated steel*

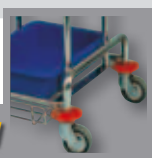

Acciaio Rilsan
Rilsan protection steel



Acciaio inox
Stainless steel (AISI 304)





MX 90
cm 83 x 56 x 105 h



MX 100
cm 83 x 56 x 105 h



MX 200
cm 83 x 56 x 105 h



MX 201
cm 83 x 56 x 105 h



Coperchio con leggio
porta documenti
*Lid with transparent
document holder* ■

Sportelli
per nascondere
il sacco rifiuti ■
*Doors to hide
waste bag*

Applicazioni
How to use



MX 202
cm 83 x 56 x 105 h



CLEANING - Carrelli Multiuso
CLEANING - Service Cars



Riciclabile
Recyclable



Montaggio veloce
Quick assembly



Anti ruggine
Rustproof



Conforme
Compliance

Plastica
Plastic



MX 203
cm 83 x 56 x 105 h



MX 204
cm 105 x 56 x 105 h



MX 300
cm 110 x 56 x 105 h



Applicazioni



How to use

Brevettato/Patented

Cursore scorrevole per l'uso di due sacchi per la raccolta differenziata. Lo scorrimento permette di aumentare l'imboccatura del sacco durante la raccolta.

Sliding mechanism that allows to use two bags for separate waste collection. Such sliding action allows to adapt the opening of the bag during collection.



MX 301
cm 110 x 56 x 105 h



MX 302
cm 110 x 56 x 105 h

Plastica
Plastic



Riciclabile
Recyclable



Montaggio veloce
Quick assembly



Anti ruggine
Rustproof



Conforme
Compliance

CLEANING - Carrelli Multiuso
CLEANING - Service Cars



MX 303
cm 110 x 56 x 105 h



MX 304
cm 110 x 56 x 105 h



MX 305
cm 110 x 56 x 105 h



n. 7 portamanici innovativi
in dotazione ad ogni modello
*In detail: innovating handle
holder (7 with every model)*



Art. 21028
Ruota morbida Ø 125 mm
per esterni
Outdoor soft castor (Ø125 mm)

Dispositivo
di alloggiamento del
pannello segnaletico
all'interno
dello sportello
sinistro.

*Left door equipped
with hooks for
housing sign-panel.*



Applicazioni
How to use



CLEANING - Carrelli Multiuso
CLEANING - Service Cars



Riciclabile
Recyclable



Montaggio veloce
Quick assembly



Anti ruggine
Rustproof



Conforme
Compliance

Plastica
Plastic



MX 400
cm 110 x 56 x 105 h



MX 401
cm 110 x 56 x 105 h



MX 402
cm 110 x 56 x 105 h



MX 403
cm 110 x 56 x 105 h



Plastica
Plastic



Riciclabile
Recyclable



Montaggio veloce
Quick assembly



Anti ruggine
Rustproof



Conforme
Compliance

CLEANING - Carrelli Multiuso
CLEANING - Service Cars



23078
cm 60 x 38 x 96 h



MX 500
cm 110 x 56 x 105 h



MX 600 VILLAGE
cm 110 x 56 x 105 h



optional
Art. 23098



Applicazioni
How to use



CLEANING - Carrelli Multiuso
CLEANING - Service Cars



Riciclabile
Recyclable



Montaggio veloce
Quick assembly



Anti ruggine
Rustproof



Conforme
Compliance

Plastica
Plastic



Plastica
Plastic



Riciclabile
Recyclable



Montaggio veloce
Quick assembly



Anti ruggine
Rustproof



Conforme
Compliance

CLEANING - Carrelli Multiuso
CLEANING - Service Cars



IDEAPLUS 15
IDEAPLUS 25
cm 70 x 54 x 125 h



IDEABASE 1
cm 83 x 52 x 105 h



IDEABASE 1 PL
cm 83 x 52 x 105 h



IDEABASE 4
cm 83 x 52 x 105 h



IDEABASE 4 PL
cm 83 x 52 x 105 h



IDEABASE 5
cm 95 x 52 x 105 h

CLEANING
Carrelli Multiuso
CLEANING
Service Cars



Riciclabile
Recyclable



Montaggio veloce
Quick assembly



Anti ruggine
Rustproof



Conforme
Compliance

Plastica e
acciaio Rilsan
Plastic and Rilsan
protected Steel



IDEABASE 6
cm 95 x 52 x 105 h



IDEABASE 6 PL
cm 95 x 52 x 105 h



IDEABASE 7
cm 83 x 52 x 105 h



IDEABASE 7 PL
cm 83 x 52 x 105 h



IDEABASE 7 PL DUO
cm 83 x 52 x 105 h



IDEABASE 8
cm 83 x 52 x 105 h



Plastica e
acciaio Rilsan
*Plastic and Rilsan
protected Steel*



Riciclabile
Recyclable



Montaggio veloce
Quick assembly



Anti ruggine
Rustproof



Conforme
Compliance

CLEANING
Carrelli Multiuso
CLEANING
Service Cars



IDEABASE 9
cm 83 x 52 x 105 h



IDEABASE 9 PL
cm 83 x 52 x 105 h



IDEABASE 10
cm 110 x 52 x 105 h



IDEABASE 11
cm 110 x 52 x 105 h



IDEABASE 11 FR
cm 110 x 52x 105 h



IDEABASE 12
cm 110 x 52 x 105 h



CLEANING
Carrelli Multiuso
CLEANING
Service Cars



Riciclabile
Recyclable



Montaggio veloce
Quick assembly



Anti ruggine
Rustproof



Conforme
Compliance

Plastica e
acciaio Rilsan
Plastic and Rilsan
protected Steel



Applicazioni 
How to use

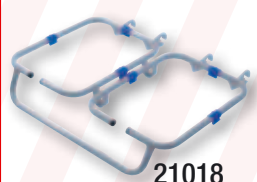

21018
optional

IDEABASE 13
cm 110 x 52 x 105 h



IDEABASE 13 PL
cm 110 x 52 x 105 h



IDEABASE 14
cm 110 x 52 x 105 h



IDEABASE 15
cm 110 x 52 x 105 h



IDEABASE 16
cm 135 x 61 x 113 h



IDEABASE 17
cm 135 x 61 x 113 h

Plastica e
acciaio Rilsan
*Plastic and Rilsan
protected Steel*



Riciclabile
Recyclable



Montaggio veloce
Quick assembly



Anti ruggine
Rustproof



Conforme
Compliance

CLEANING
Carrelli Multiuso
CLEANING
Service Cars



IDEABASE 18
cm 120 x 60 x 116 h



IDEABASE 20
cm 95 x 52 x 105 h



IDEABASE 21
cm 95 x 52 x 105 h



Dotazione ideabase 16/17:
4 portamanici integrati e 2 ganci.

Equipped with: 4 integrated handle holders and 2 hanging hooks.



Applicazioni
How to use



optional
Art. 21060
(2x120 lt)

Applicazioni
How to use



CLEANING
Carrelli Multiuso
CLEANING
Service Cars



Riciclabile
Recyclable



Montaggio veloce
Quick assembly



Anti ruggine
Rustproof



Conforme
Compliance

Plastica e
acciaio Rilsan
Plastic and Rilsan
protected Steel



IDEABLU 51
cm 83 x 52 x 105 h



IDEABLU 52
cm 83 x 52 x 105 h



IDEABLU 53
cm 110 x 52 x 105 h



IDEABLU 54
cm 110 x 52 x 105 h



IDEABLU 55
cm 110 x 52 x 107 h



optional
Art. 5027/R ■

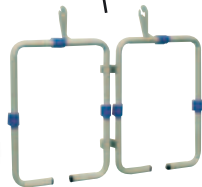

■ Art. 7031 (optional)

■ Art. 21050 (optional)



Applicazioni
How to use



Plastica e
acciaio Rilsan
*Plastic and Rilsan
protected Steel*



Riciclabile
Recyclable



Montaggio veloce
Quick assembly



Anti ruggine
Rustproof



Conforme
Compliance

CLEANING
Carrelli Multiuso
CLEANING
Service Cars



MINIMAX 2
cm 55 x 45 x 97 h



MINIMAX 3
cm 55 x 45 x 110 h



MINIMAX 2-3
(Pieghevole)
(Folding)



Applicazioni
How to use



L 1.75.80
cm 75 x 44 x 103 h



LP 2.75.80
cm 75 x 44 x 103 h



CLEANING - Carrelli Multiuso
CLEANING - Service Cars

Acciaio cromato
Chromium plated steel



L 2.90.100
cm 90 x 44 x 105 h



L 2.115.100
cm 115 x 44 x 105 h



LSC 2.125.100
cm 125 x 44 x 105 h



L 2.125.100
cm 125 x 44 x 105 h



HO 8001
cm 120 x 50 x 105 h



HO 8002
cm 95 x 50 x 105 h



Acciaio cromato
Chromium plated steel

CLEANING - Carrelli Multiuso
CLEANING - Service Cars



JOKER 1
cm 75 x 40 x 103 h



JOKER 2
cm 100 x 40 x 103 h



JOKER 3
cm 100 x 40 x 103 h



JOKER 4
cm 100 x 60 x 105 h



CLEANING - Carrelli Multiuso
CLEANING - Service Cars

Acciaio cromato
Chromium plated steel



JOKER 5

cm 100 x 60 x 105 h



JOKER 6

cm 100 x 45 x 105 h



JOKER 7

cm 80 x 45 x 105 h

Art. 8311/R

Art. 8310

optional
Art. 5027

optional
Art. 5051

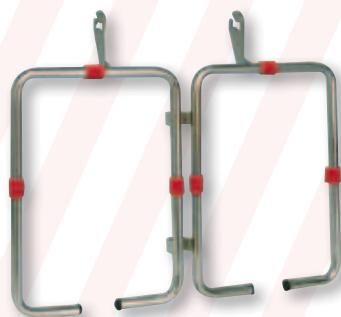

Applicazioni
How to use



Acciaio cromato
Chromium plated steel

CLEANING - Carrelli Multiuso
CLEANING - Service Cars



H 5001
cm 110 x 60 x 105 h



H 5002
cm 80 x 60 x 105 h



H 5004
cm 110 x 60 x 105 h



H 5006
cm 110 x 60 x 105 h



CLEANING - Carrelli Multiuso
CLEANING - Service Cars

Acciaio cromato
Chromium plated steel



H 5007

cm 45 x 50 x 105 h



H 5008

cm 80 x 45 x 105 h



H 5009

cm 110 x 60 x 105 h



H 5010

cm 140 x 60 x 105 h



Acciaio cromato
Chromium plated steel

CLEANING - Carrelli Multiuso
CLEANING - Service Cars



EF 7051

cm 75 x 55 x 105 h



EF 7052

cm 75 x 55 x 105 h



EF 7053

cm 100 x 55 x 105 h



EF 7054

cm 50 x 55 x 105 h



CLEANING - Carrelli Multiuso
CLEANING - Service Cars

Acciaio cromato
Chromium plated steel



EFH 7055

cm 115 x 60 x 105 h



EFH 7056

cm 140 x 60 x 105 h



Art. 7009

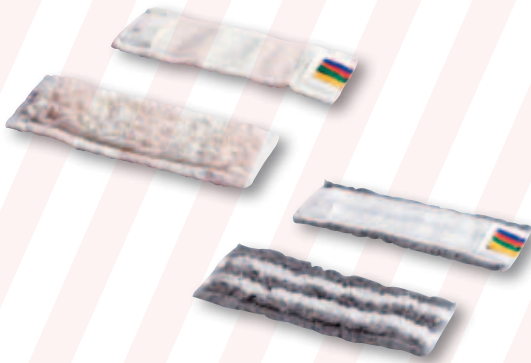

Art. 7009 MF

Art. 7008



Applicazioni
How to use



Acciaio cromato
Chromium plated steel

CLEANING - Carrelli Multiuso
CLEANING - Service Cars



EUROPE
cm 68 x 45 x 100 h



EUROPE 2
cm 95 x 50 x 105 h



L 1.75.80/R
cm 75 x 44 x 103 h



L 2.115.100/R
cm 90 x 44 x 105 h



CLEANING - Carrelli Multiuso
CLEANING - Service Cars

Acciaio con protezione Rilsan
Rilsan protected steel



BIOR 1
cm 110 x 60 x 105 h



BIOR 2
cm 100 x 60 x 105 h



BIOR 3
cm 100 x 40 x 103 h



BIOR 4
cm 75 x 40 x 103 h



Art. 8311/R Art. 8310



optional
Art. 5027/R

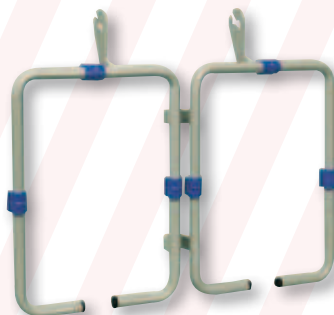

optional
Art. 5051

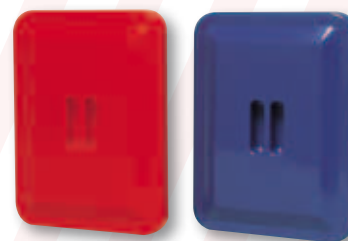

Applicazioni
How to use



Acciaio con protezione Rilsan
Rilsan protected steel

CLEANING - Carrelli Multiuso
CLEANING - Service Cars



BIOSTEEL 1
cm 125 x 60 x 108 h



BIOSTEEL 2
cm 90 x 60 x 108 h



BIOSTEEL 3
cm 120 x 60 x 108 h



BIOSTEEL 3 TC
cm 120 x 60 x 108 h



CLEANING - Carrelli Multiuso
CLEANING - Service Cars

Acciaio INOX (AISI 304)
Stainless steel (AISI 304)



BIOSTEEL 4
cm 125 x 60 x 108 h



BIOSTEEL 5
cm 125 x 60 x 108 h



BIOSTEEL 6
cm 125 x 60 x 108 h



BIOSTEEL 7
cm 145 x 60 x 108 h



optional
Art. 2770
(2x120 lt)

Applicazioni
How to use



Acciaio INOX (AISI 304)
Stainless steel (AISI 304)

CLEANING - Carrelli Multiuso
CLEANING - Service Cars



BIOSTEEL 8
cm 100 x 60 x 108 h



BIOSTEEL 9
cm 100 x 45 x 108 h



BIOSTEEL 10
cm 70 x 45 x 106 h



BIOSTEEL X
cm 53 x 50 x 104 h



CLEANING - Carrelli Multiuso
CLEANING - Service Cars

Acciaio INOX (AISI 304)
Stainless steel (AISI 304)



BIOSTEEL 11
cm 125 x 60 x 108 h



 **Brevettato/Patented**



BIOSTEEL 11 CHIUSO
CLOSED
cm 90 x 60 x 140 h



Applicazioni
How to use



BIOSTEEL12
cm 125 x 60 x 108 h

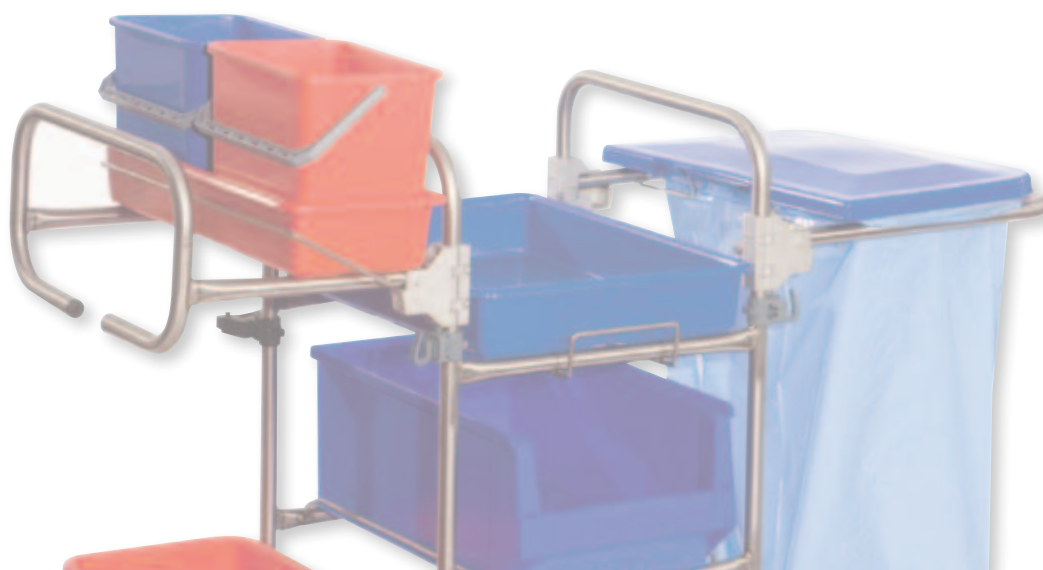

Acciaio INOX (AISI 304)
Stainless steel (AISI 304)

CLEANING - Carrelli Multiuso
CLEANING - Service Cars



Strizzatori
Wringers

La più completa gamma di strizzatori di eccellente qualità e affidabilità.

The widest range of high quality wringers.



Strizzatore a rullo ELPAROLL
ELPAROLL roller wringer

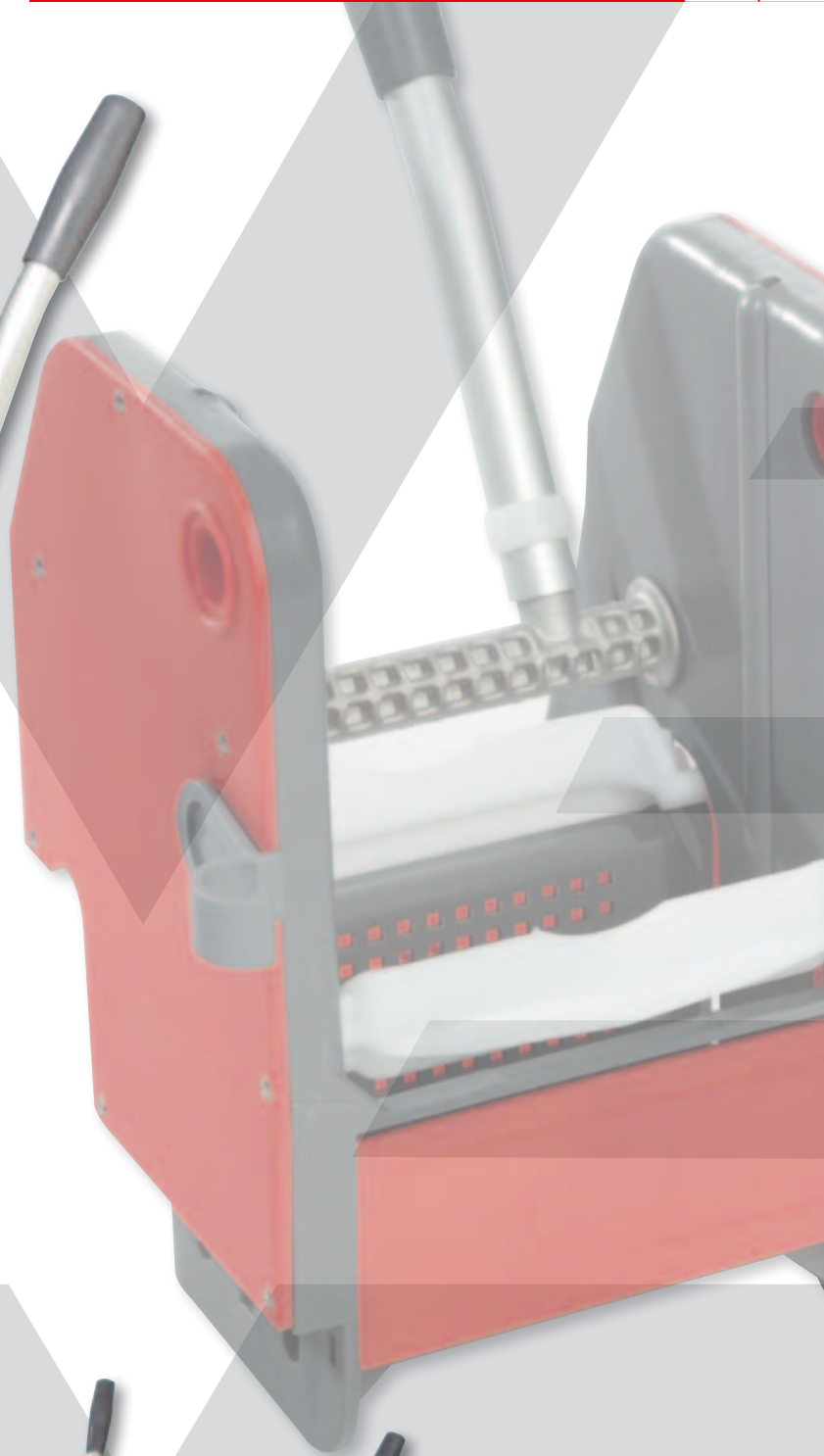

Strizzatori in plastica/*Plastic wringers*



4000 P



4100 P



4100 P/A



4300 P (MAXI)



3000 Z



Strizzatori
Wringers



3501



7001

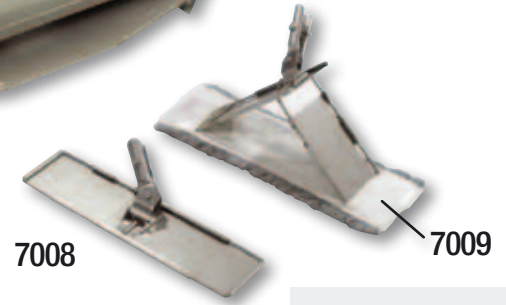

7008

7009



7001
7008/7009

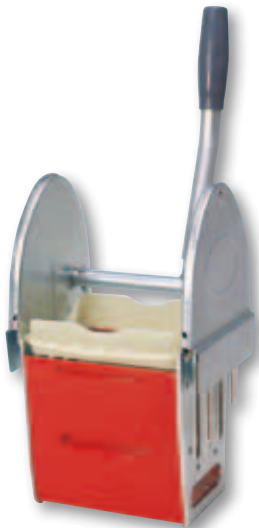

1010
disponibile con
pressini in alluminio

*Available with
alu. pressure plate*



4550 (MICROROLL)



4550/2250
capacità 6 lt
6 lt. capacity



4550/1067
capacità 15 lt
15 lt. capacity

Strizzatori
Wringers



Secchi e componenti in plastica ***Buckets and plastic components***

Secchi di varie forme e capacità.
Componenti e accessori in plastica
per carrelli.

***Buckets of various sizes and
capacity.
Plastic components and accessories
for trolleys.***



Polipropilene Copolimero/*Polypropilene Copolymer*

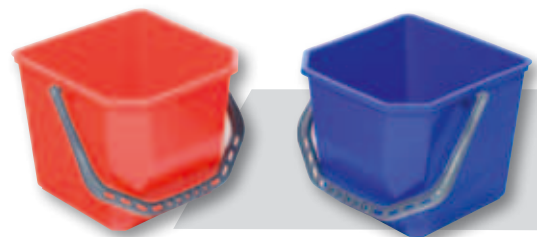

Polipropilene Copolimero
Polypropilene Copolymer



Polipropilene Copolimero/*Polypropilene Copolymer*

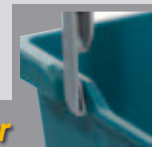

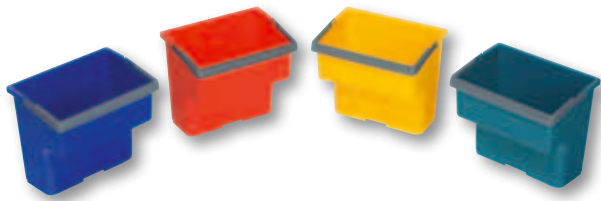

23020 (4 lt.)
cm 24 x 17/9 x 22 h



2250 (6 lt.)
cm 26 x 19 x 22 h



2251



2253



2250 (6 lt.)
2251
cm 26 x 19 x 22 h



2250 AUS (6 lt.)
autoestinguente
self-extinguishing
cm 26 x 19 x 22 h



4635 (9 lt.)
cm 30 x 19/13 x 25 h

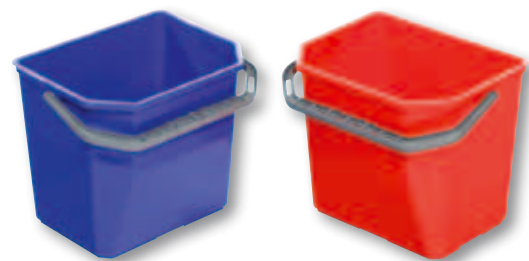

2235 (12 lt.)
cm 31 x 24,5 x 26 h



Secchi e componenti in plastica
Buckets and plastic components



1205 (15 lt.)
cm 34 x 34 x 27,5 h



1005 (25 lt.)
cm 34 x 35,5 x 32 h



21005 (15 lt.)
cm 31,5 x 32/20 x 33 h



2306 (6 lt.)
cm 47 x 12 x 30 h



2270 (13 lt.)
cm 47 x 22 x 21 h



7038

7030 (22 lt.)
cm 54 x 27 x 27 h



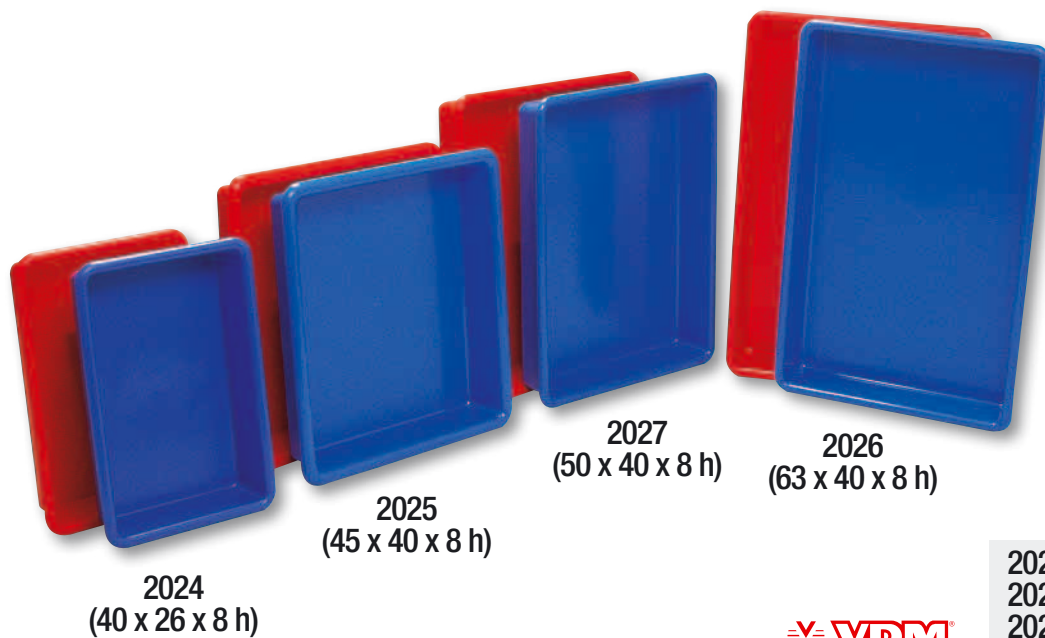

2024
(40 x 26 x 8 h)

2025
(45 x 40 x 8 h)

2027
(50 x 40 x 8 h)

2026
(63 x 40 x 8 h)

2024
2025
2026
2027

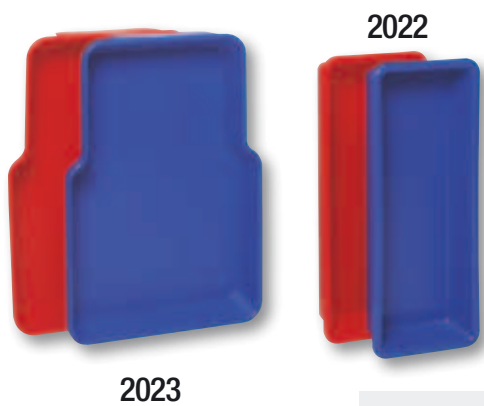

2023

2022

2023 (MINIMAX)
cm 32/38 x 54 x 8 h

2022 (BIOS)
cm 50 x 20 x 8 h



21010

21070

21010
cm 45 x 26 x 9 h

21070
cm 61 x 39 x 9 h



24051

24053

24051
cm 53 x 20 x 12 h

24053
cm 52 x 14 x 12 h



23015 VS

cm 42 x 28 x 8,5 h



Componenti in plastica
Plastic components



2710
Cursore
Plastic Device



8311

8310

8311
8310



2255 (Ø 22)
5065 (Ø 20)



4022 (Ø22)
4024 (Ø24)



2215 (Ø15)
5018/G (Ø20)
2231 (Ø22)
2234 (Ø24)



Brevettato/Patented

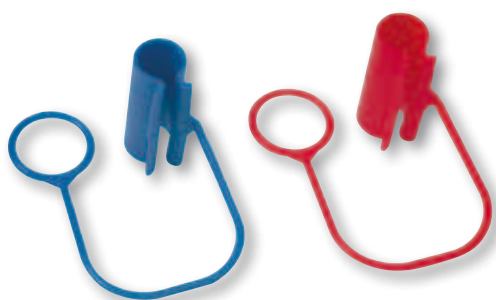

1701

1702

1701
1702
Clips con anello
Plastic Clips with ring



Art. 2230 (Ø 22)
Art. 5018 (Ø 20)

Applicazioni
How to use



Componenti in plastica
Plastic components



Telai e Frange per uso a secco
Dust flat mops and frames

Telai e frange ad uso professionale di diverse misure e materiali.

Professional dust flat mops and frames of various sizes and different materials.



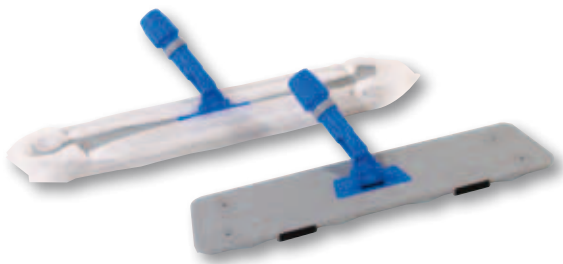

4087
Telaio in gomma
Rubber dust tool



6020
cm 60 x 20
6030
cm 60 x 30
Panni elettrostatici
Electrostatic dust cloth

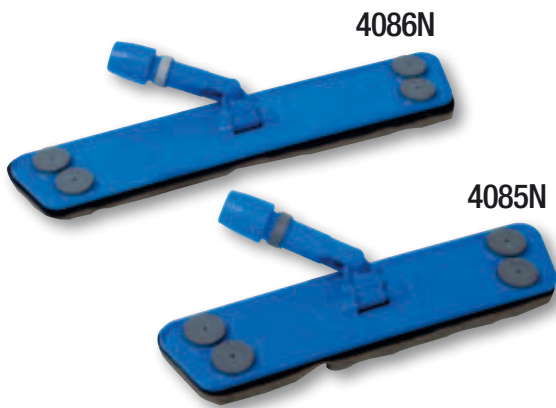

4085N
cm 40 x 9 h
4086N
cm 50 x 9 h

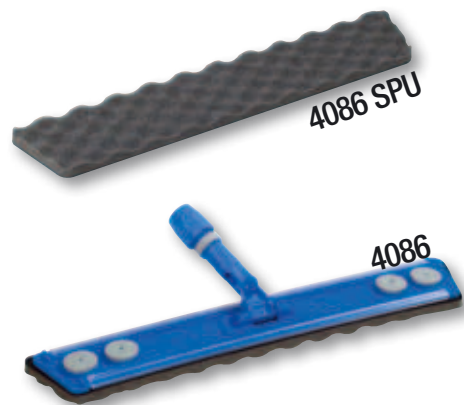

4086 - 4086SPU
cm 55 x 9 h



Panni impregnati
Electrostatic dust cloth
4181 - cm 60 x 17
4182 - cm 60 x 20
4183 - cm 60 x 30
4184 - cm 60 x 22



Garze Cotone
Cotton Gauzes
6041 - cm 60 x 80
6042 - cm 100 x 80
6043 - cm 120 x 80
6044 - cm 140 x 80

Telai e Frange per uso a secco
Dust flat mops and frames

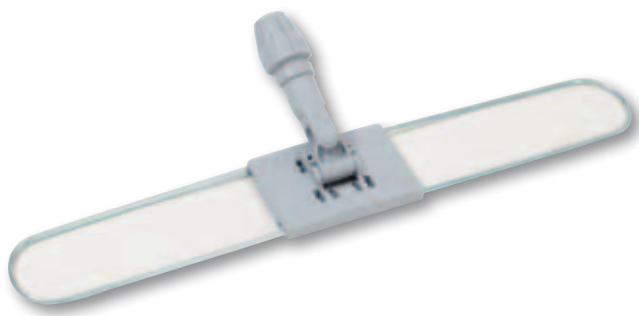

4041 - cm 40
 4042 - cm 60
 4043 - cm 80
 4044 - cm 100



4041/N - cm 40
 4042/N - cm 60
 4043/N - cm 80

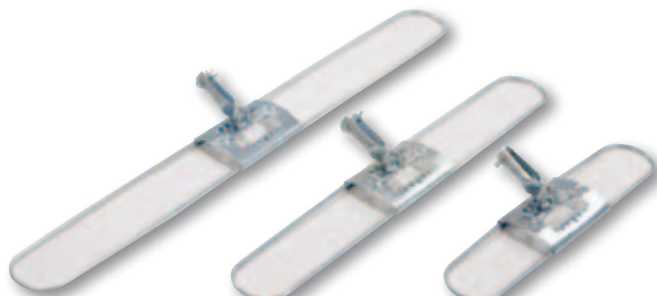

4043/M

4042/M

4041/M

4041/M - cm 40
 4042/M - cm 60
 4043/M - cm 80



4047 - cm 160

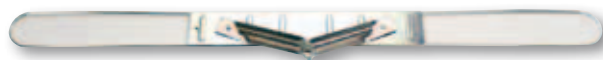

4046 - cm 130

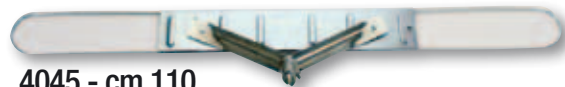

4045 - cm 110

4045
 4046
 4047

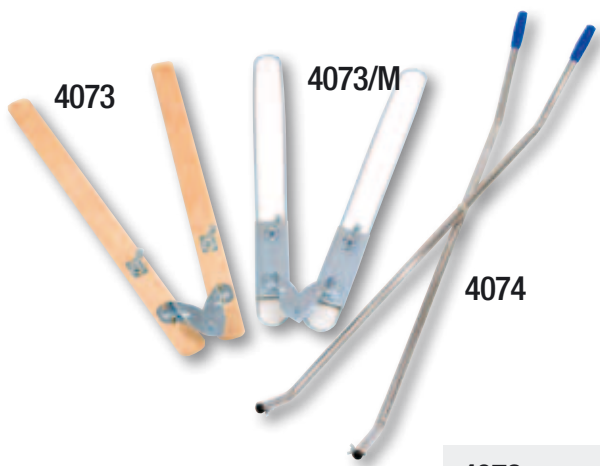

4073

4073/M

4074

4073
 4073/M
 4074

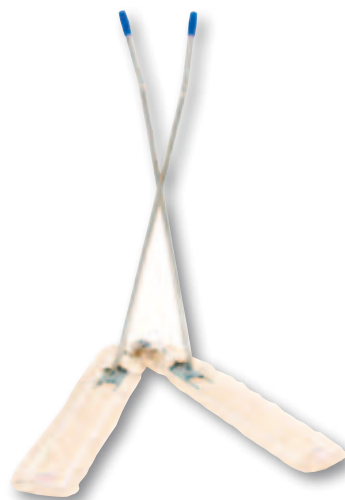

4071
 4071/M
 cm 100 + 100



Telai e Frange per uso a secco
Dust flat mops and frames



Cotone
Cotton



4131 - cm 40
4132 - cm 60
4133 - cm 80
4134 - cm 100



Sintetico
Synthetic



4141 - cm 40
4142 - cm 60
4143 - cm 80
4144 - cm 100



Cotone
Cotton



4051 - cm 40
4052 - cm 60
4053 - cm 80
4054 - cm 100



Sintetico
Synthetic



4061 - cm 40
4062 - cm 60
4063 - cm 80
4064 - cm 100



Cotone Cotton	Sintetico Synthetic
4055 - cm 110	4065 - cm 110
4056 - cm 130	4066 - cm 130
4057 - cm 160	4067 - cm 160



4072/S

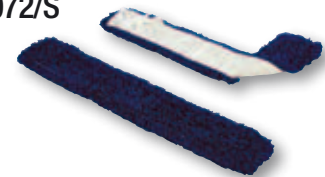

Sintetico
Synthetic

4072

Cotone
Cotton



4072 - cm 100
4062/S - cm 100



Telai e Frange per uso a secco
Dust flat mops and frames



Telai e Frange per uso a secco
Dust flat mops and frames

A collection of professional wet flat mops and frames. The top mop has a blue frame and white fringes. Below it is a mop with a yellow frame and grey fringes. At the bottom right, there is a smaller mop with a blue frame and red fringes. The background is a plain, light-colored surface.

Telai & Frange per lavare

Wet Flat mops and Frames

Telai e frange ad uso professionale di diverse misure e materiali.

Professional wet flat mops and frames of various sizes and different materials.



4080/N
(50 x 13)



4083/N
(40 x 13)



4075
(40 x 11)



4081



4084



4076

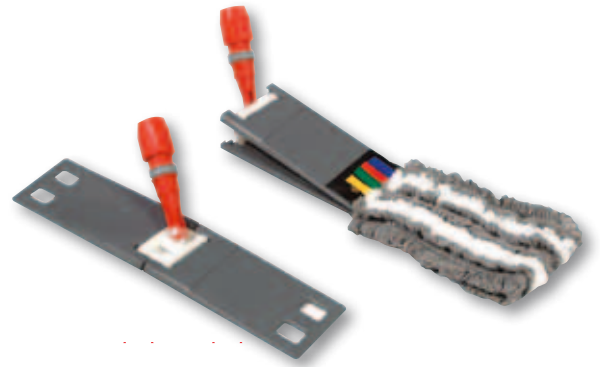

4075 - 4076
4083/N - 4084
4080/N - 4081



3502 (ELPAROLL)
cm 45 x 10 h

Telaio "CLACK"

"CLACK" Frame

(cm 40 x 11)



3720



3710



3710
cm 40 x 11 h

Telaio a pedale
"ELPAROLL"

*"ELPAROLL" frame
(Pedal)*

(cm 45 x 11)



3503



3506



3506
cm 45 x 10 h

Telai & Frange per lavare
Wet Flat Mops and Frames



7033



0481

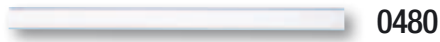

0480



7033 (TRAPEZE)

cm 40 x 9 h



7081

cm 40 x 9 h



Acciaio Inox (AISI 304)
Stainless steel (AISI 304)

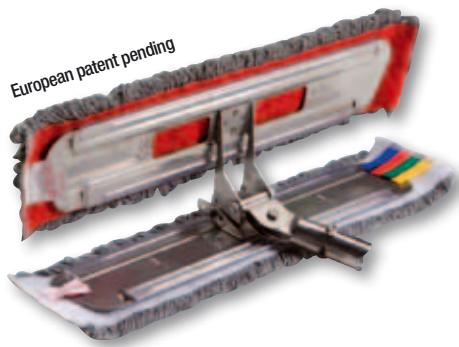

Lava & Asciuga
Wet & Dry



7083

cm 40 x 22 h



Acciaio Inox (AISI 304)
Stainless steel (AISI 304)



7011

7039

7011 - cm 45
7039 - cm 45



4086 SS (Trapeze)

cm 60



7008

7009



7008 - 7009

cm 40 x 10 h



Acciaio Inox (AISI 304)
Stainless steel (AISI 304)

Telai & Frange per lavare
Wet Flat Mops and Frames



3505

3503

3503
cm 45

3505
cm 45



3504 Microfibre

cm 45



3720

cm 45



3720 MF Microfibre

cm 40



7009

cm 40

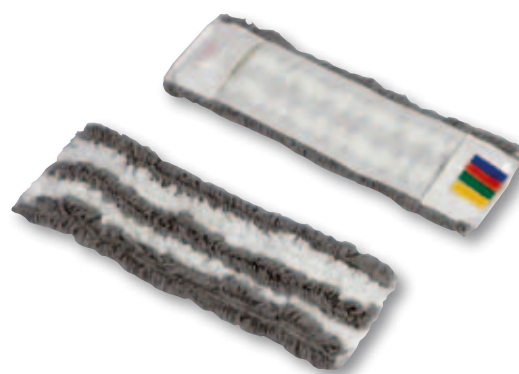

7009 MF Microfibre

cm 40



Telai & Frange per lavare
Wet Flat Mops and Frames

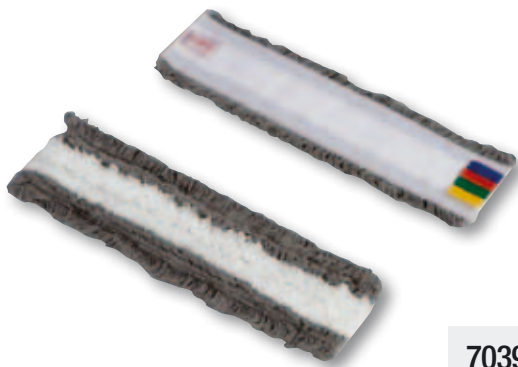

7039 Microfibre
cm 45



7025 Microfibre
cm 45 - con velcro
60661 Microfibre
cm 40 - con occhielli
60662 Microfibre
cm 40 - con tasche

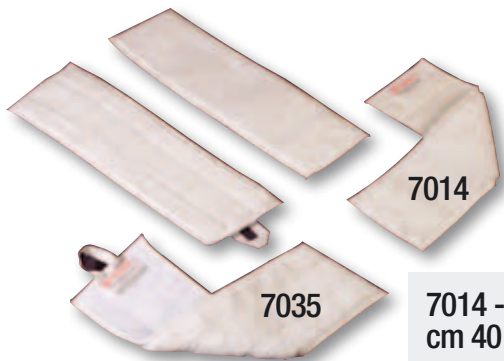

7014
7035
7014 - Microfibre
cm 40
7035 - Microfibre
cm 44



7011
cm 45



4076 MF
4076
4076
cm 40
4076 MF Microfibre
cm 40

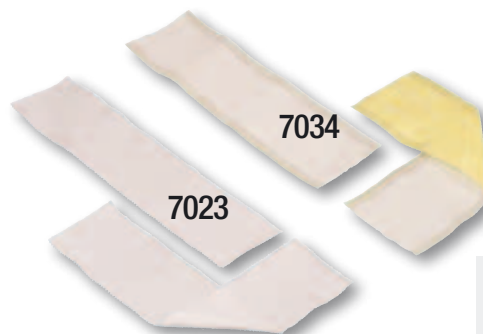

7034
7023
7023 - Microfibre
cm 45
7034 - Microfibre
cm 42
Monouso
Disposable



7035 A
Frangia Microfibre
con abrasivo
cm 40

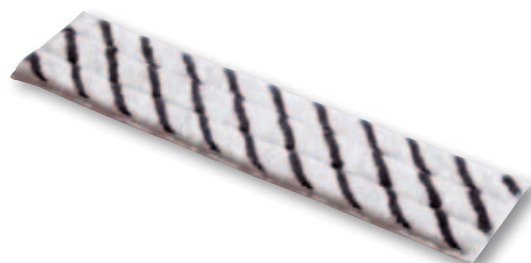

4086 FRA
Frangia Microfibre
con abrasivo
cm 60



Mop in cotone e in TNT
Cotton & TNT Kentucky Mops

Mop in cotone “extra” ed in viscosa di vari pesi e misure. Con e senza banda ad uso professionale.

Professional cotton or viscose kentucky Mops of different weights and sizes, with or without bands.





4010



4010
colori vari
colour code



4019

4025

4421

1058

4426 (telescopic)

4020 (2 pcs)



1058 - Ø 22 x 130 cm
4019 - Ø 24 x 150 cm
4020 - Ø 22 x 145 cm
4025 - Ø 24 x 145 cm
4421 - Ø 23,5 x 140 cm
4426 - 160 cm



4032 N (TNT)



gr. 250 ÷ 300

Mop in cotone e in TNT
Kentucky Mops



60653
MOP "MICROFIBRA"

250 gr.
filo continuo con banda



4030



4030/350 gr.
4030/400 gr.
4030/450 gr.
4030/500 gr.



4031



4031/350 gr.
4031/400 gr.
4031/450 gr.
4031/500 gr.

Mop in cotone
Kentucky Mops

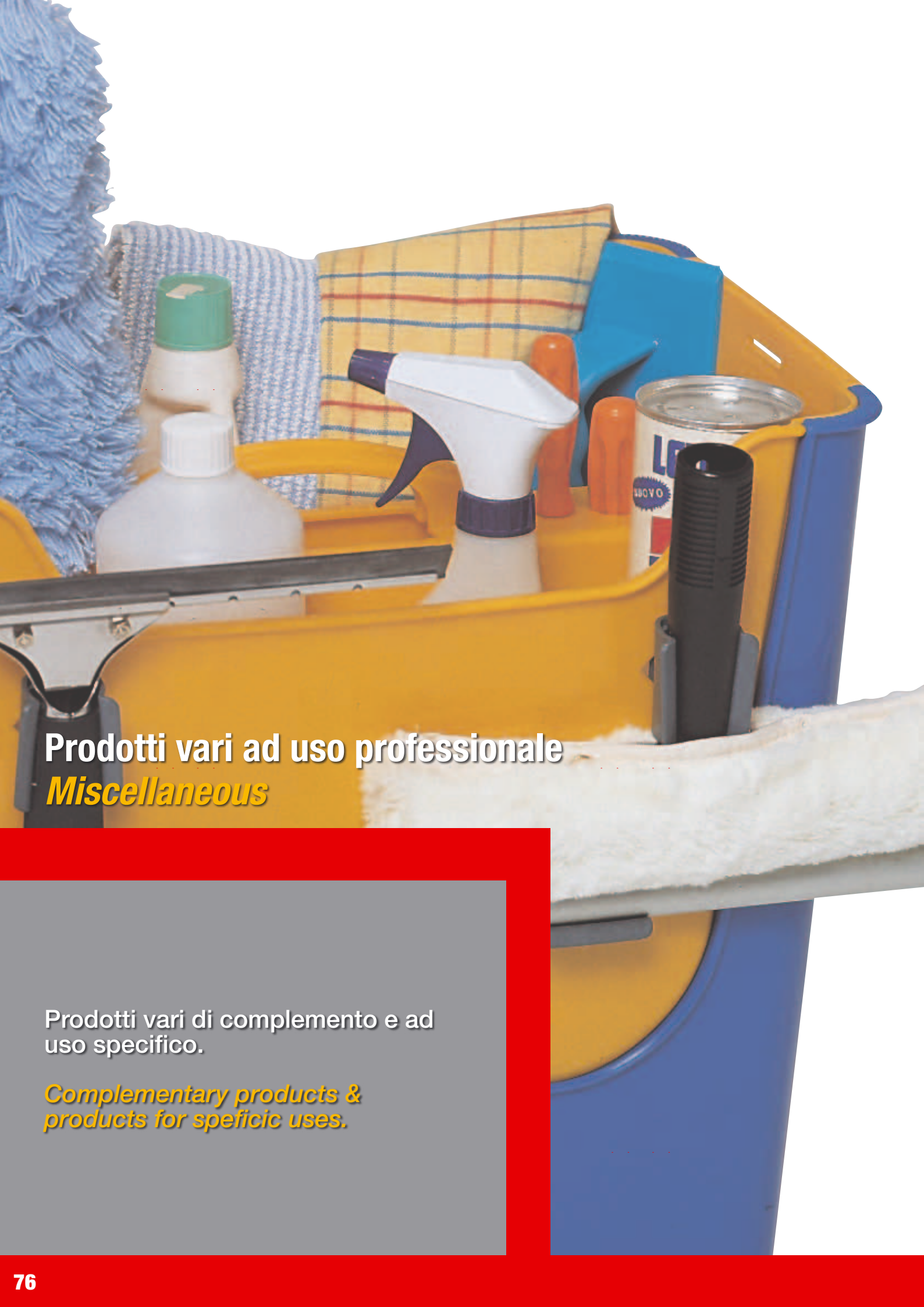

Prodotti vari ad uso professionale
Miscellaneous

Prodotti vari di complemento e ad uso specifico.

Complementary products & products for specific uses.

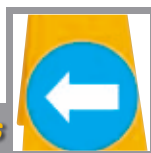

Pannelli di segnalazione/ *Sign panels*

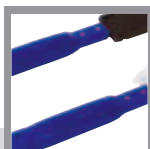
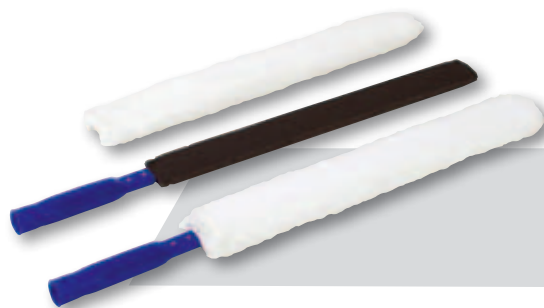

Spolverino professionale
Professional duster



Set multiuso "Gipsy"/ *Multipurpose set "Gipsy"*



4090 - 4091
cm 23 x 10 h

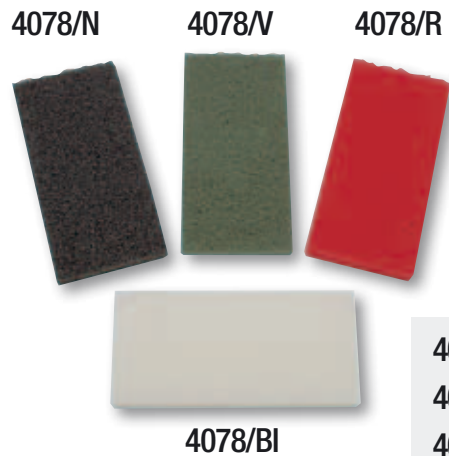

4078/N - cm 12 x 25
4078/V - cm 12 x 25
4078/R - cm 12 x 25
4078/BI - cm 12 x 25

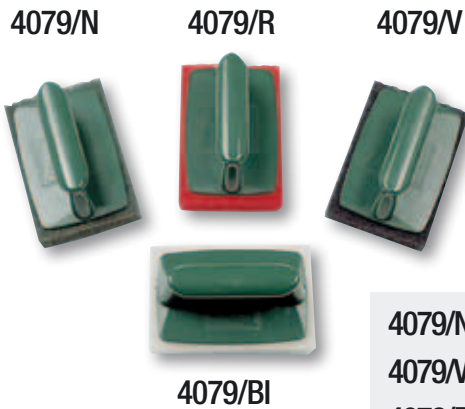

4079/N - cm 15 x 10
4079/V - cm 15 x 10
4079/R - cm 15 x 10
4079/BI - cm 15 x 10

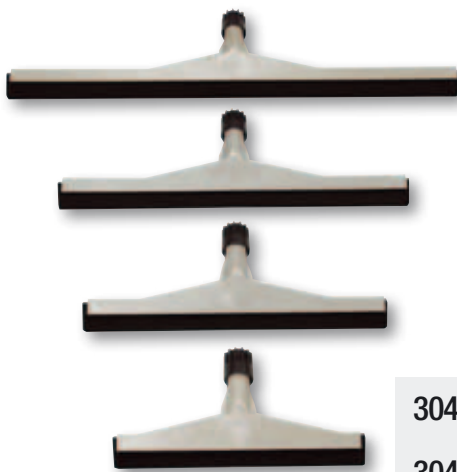

30435 - cm 35
30445 - cm 45
30455 - cm 55
30475 - cm 75

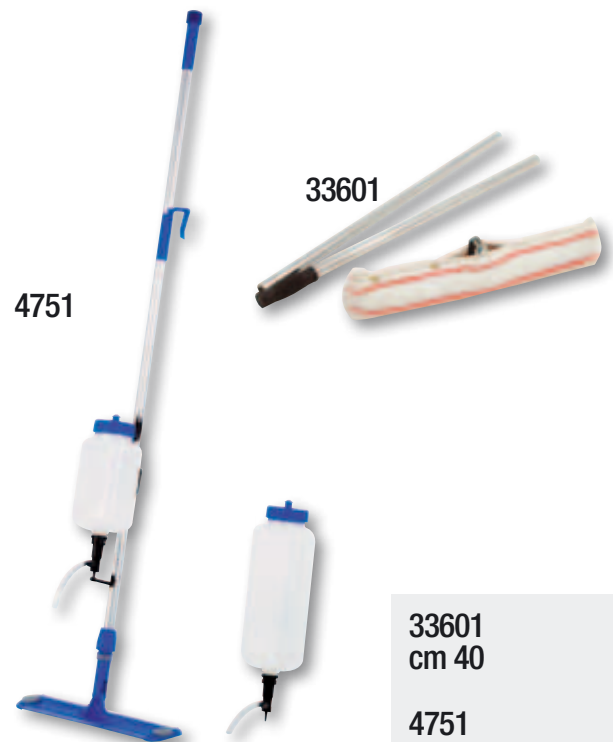

Spandicera
Wax - spreading tool

33601
cm 40

4751
applicatore cera
Jumbo-wax

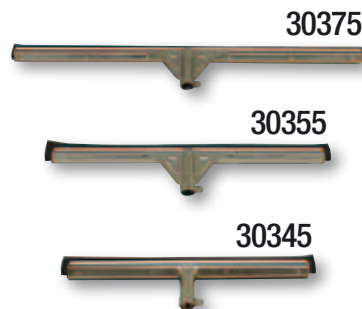

30375

30355

30345

30345 - cm 45
30355 - cm 55
30375 - cm 75



Prodotti vari ad uso professionale
Miscellaneous



Convogliatore d'acqua
con attacco universale.
*Water conveyor with
universal joint*



1071 (FAST)

mt 1,5

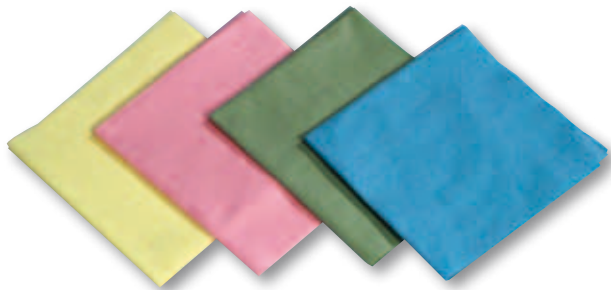

Set 4 panni
Microfibra (tessuto)
*Set 4 pcs Fabric
Microfibre Cloths*



3655

cm 40 x 40
200 gr./m²



Panni Microfibra (Tessuto)
Fabric Microfibre Cloths



3654
3652
3653
3651

cm 40 x 40
320 gr./m²



34540 - cm 40
34570 - cm 70
34599 - cm 100



 **Brevettato
Patented**

Gipsy
2306 - 2310

Prodotti vari ad uso professionale
Miscellaneous



4263/1



4263/6



4263/2



4263/7



4263/3



4263/8



4263/4

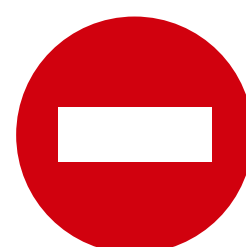

4265



4263/5

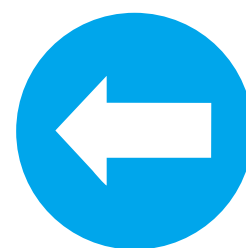

4264



4260 (MULTISIGN)

cm 20/30 x 58 h



Dischi segnaletici
Sign - Disks
Ø cm 26

Prodotti vari ad uso professionale
Miscellaneous

Pannelli di segnalazione
Multisign



4350
cm 30 x 80 h



4040
cm 25 x 95 h



4039
cm 20



4380 - 4381 - 4382
cm 60

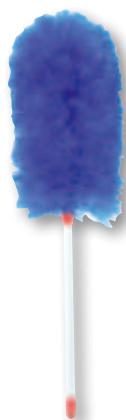

4357 - cm 50
Sintetico
Synthetic



4037 - cm 45
Piume di struzzo
Ostrich feather
4038 - cm 50
Lana
Wollen

Prodotti vari ad uso professionale
Miscellaneous

Tergivetro varie misure in acciaio inox e di plastica.

St. steel and plastic squeegees (various sizes).

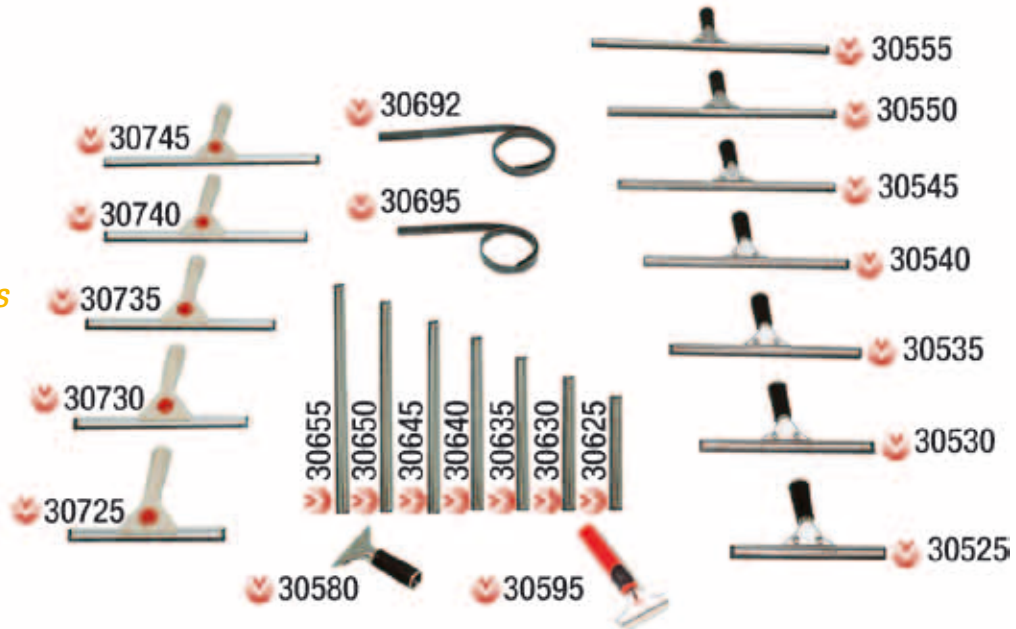

Vello lavavetro, varie misure.

Washer (various sizes).



Vello lavavetro con striscia abrasiva, varie misure.

Washer with abrasive strip (various sizes).

Tergivetro e lavavetro con impugnatura snodabile, varie misure.

Squeegee and washer with articulated handle (various sizes).



Linea vetri
Windows Range



Prodotti vari ad uso professionale
Miscellaneous

Linea vetri
Windows Range



34011

34010



34010
34011
34610



34120

34025

34000

34150

33501

33500

34200



34000 (cm 15)
34025 (cm 25)
34120 (cm 120)



2270 (13 lt.)

7030 (22 lt.)



2270 (13 lt.)
cm 47 x 22 x 21h

7030 (22 lt.)
cm 54 x 27 x 27h



33480

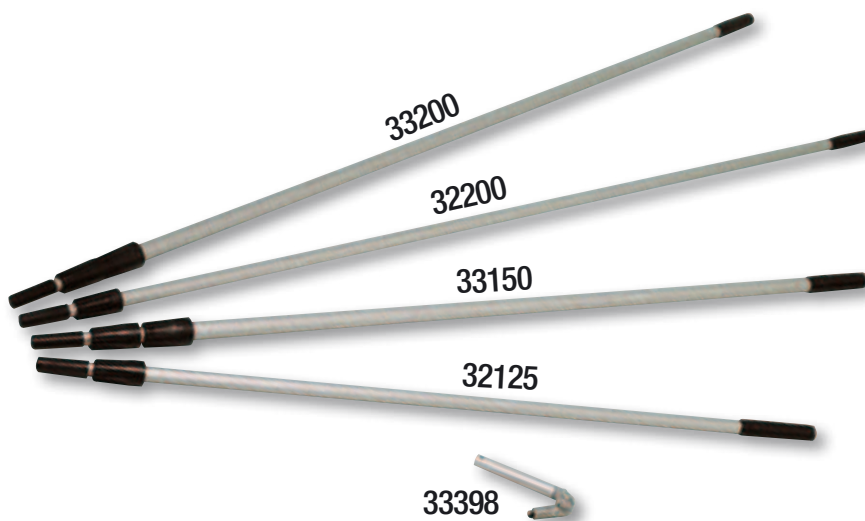

33200

32200

33150

32125

33398



32125 (2 x 1,25 mt)
32200 (2 x 2 mt)
33100 (3 x 1 mt)
33150 (3 x 1,50 mt)
33200 (3 x 2 mt)
33201 (3 x 3 mt)

Linea vetri
Windows Range

Prodotti vari ad uso professionale
Miscellaneous



Prodotti ad uso semiprofessionale
Semi-professional products

Una linea di prodotti utilizzabili in piccole superfici e per un uso non intensivo. Indicati nel settore "Catering".

Semi - professional products to be used in small ambients. Suitable for "Catering" areas.



Carrello di lavaggio / *Mopping bucket*



Secchio con strizzino per MOP / *Bucket with wringing sieve*





1067 (COMFORT)
Capacità 15 lt.
15 lt. capacity



1085
(Duo Mop 6+6 lt.)
cm 45 x 33 x 34 h



1068



1069



4019



1058

1080



1068
(Filo fine/
Thin thread)
1068/250 gr.
1068/280 gr.
1068/300 gr.

1069
1069/200 gr.
1069/250 gr.
1069/300 gr.
1069/350 gr.
1080 - TNT



3502 ■

3503 ■



CP 2600
cm 40 x 39 x 90 h

Prodotti ad uso semi-professionale
Semi-professional products



4600
cm 45 x 32 x 60 h



4630 (DUO MOP)
cm 45 x 32 x 60 h



4601
(Semi-professional)
cm 25 x 22 x 54 h

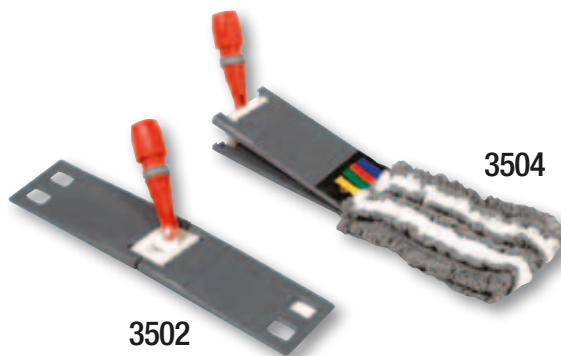

3502
cm 45 x 10



MAC 50
Codice colore
Clour code
cm 40 x 32 x 76 h

Prodotti ad uso semi-professionale
Semi-professional products



Applicazioni
How to use



3621 (x 3601)
3622 (x 3602)
3623 (x 3603)



3601 (30x10)



3602 (40x10)



3603 (50x10)



Brevettato
Patented

"CLEÓ" SYSTEM

4016 (cm 150)

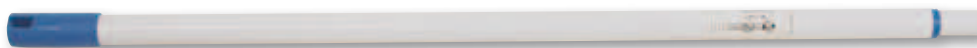

4016/F (cm 150)

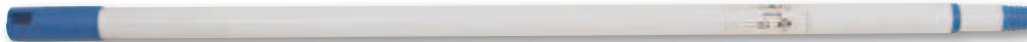

4015 (cm 130)



4015/F (cm 130)



4013



Manici Telescopici
Telescopic Handles



4086/N (cm 50x9)



4085/N (cm 40x9)



4086/SPN (cm 50)



4085/SPN (cm 40)



4086/N (cm 50x9)
4085/N (cm 40x9)
4086/SPN (cm 50)
4085/SPN (cm 40)

Prodotti ad uso semi - professionale
Semi - professional products



Prodotti ad uso semi - professionale
Semi - professional products

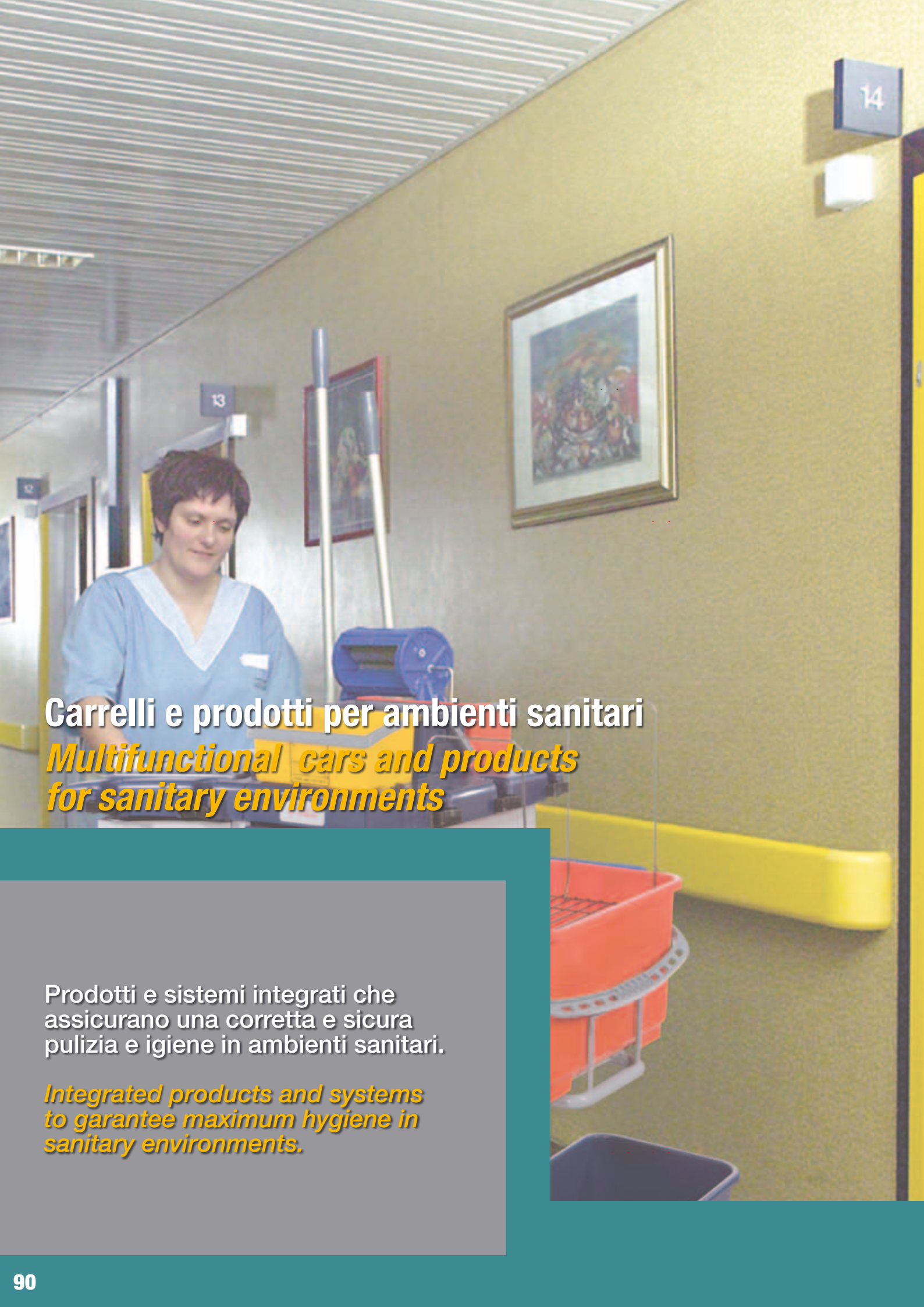

Carrelli e prodotti per ambienti sanitari
Multifunctional cars and products
for sanitary environments

Prodotti e sistemi integrati che assicurano una corretta e sicura pulizia e igiene in ambienti sanitari.

Integrated products and systems to guarantee maximum hygiene in sanitary environments.



Carrelli e prodotti per ambienti sanitari
Multifunctional cars and products for sanitary environments



MX 500
cm 110 x 56 x 105 h



Plastica
Plastic



23078
Trolley
cm 60 x 38 x 96 h



Acciao Rilsan
Rilsan protected steel



Applicazioni
How to use



IDEABASE 17
cm 135 x 61 x 113 h

Plastica e Acciao Rilsan
Plastic and Rilsan protected steel

Applicazioni
How to use
(Ideabase 17)



Carrelli specifici per ambienti sanitari
Multifunctional trolleys specific for sanitary environments



IDEABLU 56

cm 110 x 52 x 107 h



Plastica e Acciaio Rilsan
Plastic and Rilsan protected steel



IDEABLU 57

cm 110 x 52 x 107 h



Plastica e Acciaio Rilsan
Plastic and Rilsan protected steel



H 5009

cm 110 x 60 x 105 h



Acciaio Cromato
Chromium plated steel



H 5010

cm 140 x 45 x 105 h



Acciaio Cromato
Chromium plated steel

Carrelli specifici per ambienti sanitari
Multifunctional trolleys specific for sanitary environments



BIOSTEEL 3 TC

cm 120 x 60 x 108 h



Acciaio Inox (AISI 304)
Stainless steel (AISI 304)



BIOSTEEL 5

cm 125 x 60 x 108 h
(cm 90 x 60 x 140 h)



Acciaio Inox (AISI 304)
Stainless steel (AISI 304)



BIOSTEEL 6

cm 125 x 60 x 108 h
(cm 90 x 60 x 140 h)



Acciaio Inox (AISI 304)
Stainless steel (AISI 304)



BIOSTEEL 7

cm 145 x 60 x 108 h
(cm 93 x 60 x 140 h)



Acciaio Inox (AISI 304)
Stainless steel (AISI 304)

Carrelli specifici per ambienti sanitari
Multifunctional trolleys specific for sanitary environments



CAPRI 4 (80004)

cm 150/110x55x152 h



Plastica e Acciao Rilsan
Plastic and Rilsan protected steel



CAPRI 5 (80005)

cm 150/110x55x152h



Plastica e Acciao Rilsan
Plastic and Rilsan protected steel



CAPRI 6 (80006)

cm 150/110x55x152 h



Plastica e Acciao Rilsan
Plastic and Rilsan protected steel



CAPRI 7 (80007)

cm 160/110x55x152 h



Plastica e Acciao Rilsan
Plastic and Rilsan protected steel

Carrelli specifici per ambienti sanitari
Multifunctional trolleys specific for sanitary environments



4087

cm 51 x 10,5 h



Applicazioni
How to use



4075

cm 40 x 11



7014 Microfibre

cm40



4076

4076/MF



4076/MF Microfibre

cm 40



Prodotti specifici per ambienti sanitari

Miscellaneous products specific for sanitary environments



7033 (TRAPEZE)
cm 40
4086 SS (TRAPEZE)
cm 60



7081 (TRAPEZE)
cm 40 x 9



Acciaio Inox (AISI 304)
Stainless steel (AISI 304)

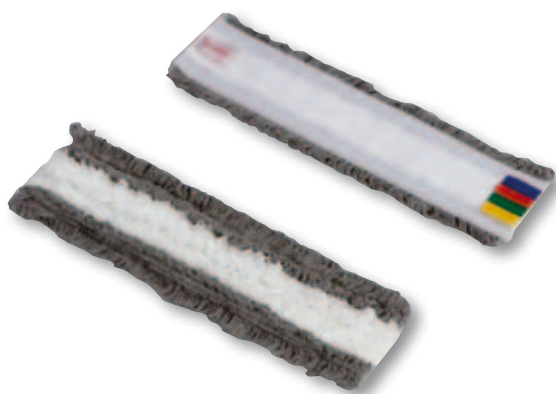

7039 Microfibre
cm 45



7025 Microfibre
cm 45



7035 Microfibre
cm 44

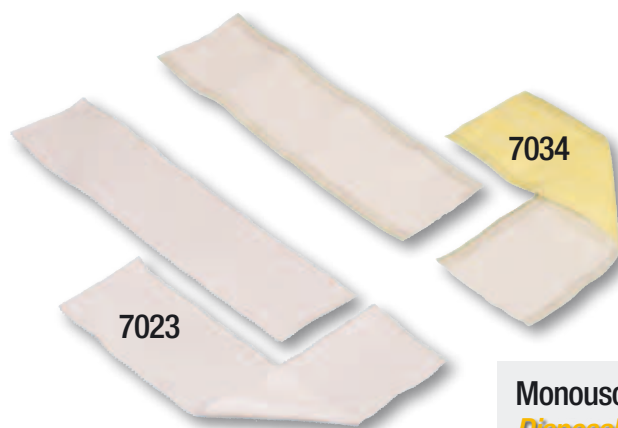

7034
Monouso
Disposable
7023 Microfibre
cm 45
7034 Microfibre
cm 42

Prodotti specifici per ambienti sanitari
Miscellaneous products specific for sanitary environments



Disponibile anche con base rigida cm 40
Available also with 40 cm rigid frame

4088
 Distributore
 disinfettante
*Disinfectant
 distributor*



4701
 Spray Mop
 Distributore
 a pressione
*Pressure system
 distributor*



7008



7001



7008
 cm 40 x 10
7001

Acciaio Inox (AISI 304)
Stainless steel (AISI 304)



7009
 Codice colore
Colour code
 cm 40

Prodotti specifici per ambienti sanitari
Miscellaneous products specific for sanitary environments



Lava & Asciuga
Wet & Dry



7083
cm 40 x 22 h



Acciaio Inox (AISI 304)
Stainless steel (AISI 304)



Per asciugare
To dry



7011
cm 45



Per lavare
To wash



7039 Microfibre
cm 45

European patent pending



Lava & Asciuga
Wet & Dry



Applicazioni
How to use



7083 - 7039 - 7011

Prodotti specifici per ambienti sanitari
Miscellaneous products specific for sanitary environments



Linea Hotel Classic
Classic Hotel line

Una vasta gamma di carrelli di linea classica, solidi e molto eleganti per alberghi di prestigio.

A wide range of stylish chambermaid trolleys of classic line and solid construction ideal for hotels of prestige.





PORTOFINO 1
da 8 a 12 camere
from 8 to 12 rooms

Colori disponibili/
Colours available
90001
frassino (chiaro)/*ash (light)*
90002
noce (scuro)/*walnut (dark)*



PORTOFINO 2
da 8 a 12 camere
from 8 to 12 rooms

Colori disponibili/
Colours available
90003
frassino (chiaro)/*ash (light)*
90004
noce (scuro)/*walnut (dark)*

Misure / *Sizes*

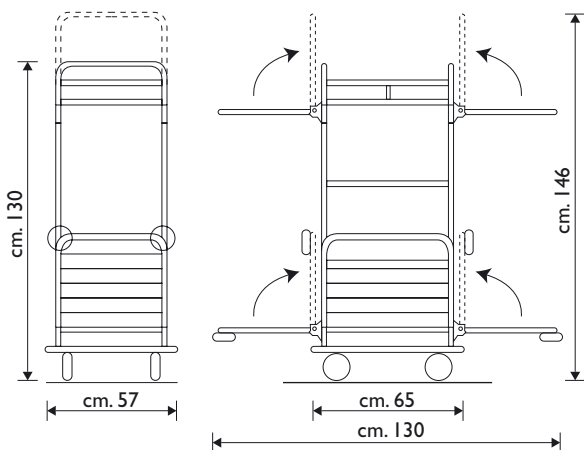

Applicazioni

How to use



CARATTERISTICHE TECNICHE
TECHNICAL CHARACTERISTICS

- Tubo Ø25x1,5 mm di spessore.
- Speciale verniciatura in polvere epossidica antigraffio.
- Rivestimento in laminato stratificato di grande spessore.
- Portofino 1 Kg 46
- Portofino 2 Kg 49
- *Square tube Ø25x1,5 mm thick.*
- *Special coating with scratchproof epoxy powder.*
- *Thick laminate layers coating.*
- *Portofino 1 Kg 46*
- *Portofino 2 Kg 49*

Carrelli hotel
Chambermaid trolleys
Classic



AMALFI 1
da 12 a 15 camere
from 12 to 15 rooms

Colori disponibili/
Colours available
90006
frassino (chiaro)/*ash (light)*
90007
noce (scuro)/*walnut (dark)*



AMALFI 2
da 12 a 15 camere
from 12 to 15 rooms

Colori disponibili/
Colours available
90008
frassino (chiaro)/*ash (light)*
90009
noce (scuro)/*walnut (dark)*

Applicazioni
How to use



Prodotto novità
New product



"Light"



CARATTERISTICHE TECNICHE
TECHNICAL CHARACTERISTICS

- Tubo Ø25x1,5 mm di spessore.
 - Speciale verniciatura in polvere epossidica antigraffio.
 - Rivestimento in laminato stratificato di grande spessore.
 - Amalfi 1 Kg 54
 - Amalfi 2 Kg 57
- *Square tube Ø25x1,5 mm thick.*
 - *Special coating with scratchproof epoxy powder.*
 - *Thick laminate layers coating.*
 - *Amalfi 1 Kg 54*
 - *Amalfi 2 Kg 57*

Misure / *Sizes*

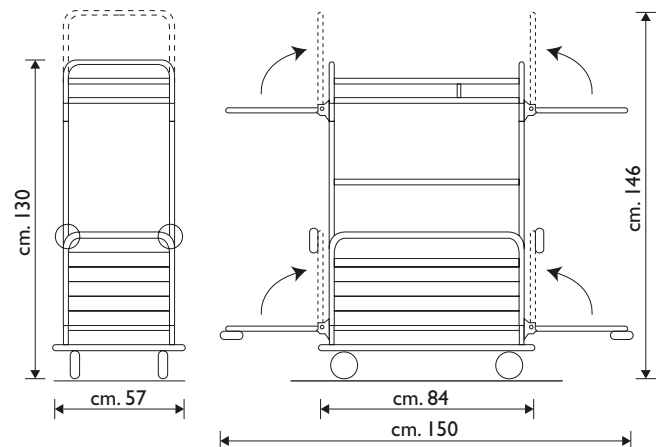

Carrelli hotel
Chambermaid trolleys
Classic



VENEZIA 1
da 15 a 18 camere
from 15 to 18 rooms

Colori disponibili/
Colours available
90010
frassino (chiaro)/*ash (light)*
90011
noce (scuro)/*walnut (dark)*



VENEZIA 2
da 15 a 18 camere
from 15 to 18 rooms

Colori disponibili/
Colours available
90012
frassino (chiaro)/*ash (light)*
90013
noce (scuro)/*walnut (dark)*

Misure / *Sizes*

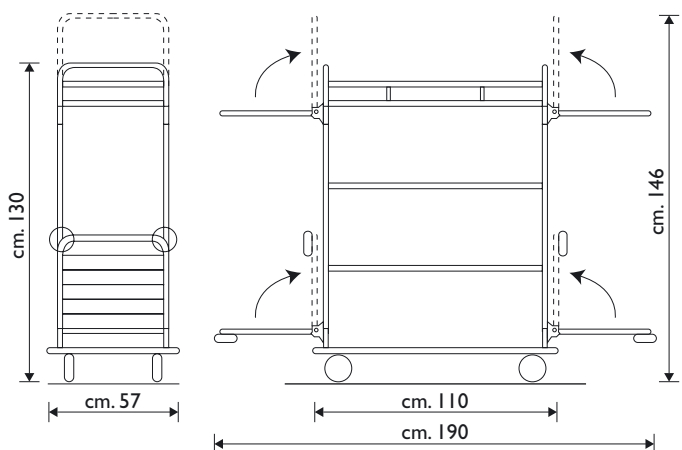

Applicazioni

How to use



Estensione per
raccolta differenziata

Extension for waste collection

90260 SET

Estensione per raccolta differenziata
Portofino/Amalfi/Venezia 1
Extension for waste collection
Portofino/Amalfi/Venezia 1

90265 SET

Estensione per raccolta differenziata
Portofino/Amalfi/Venezia 2
Extension for waste collection
Portofino/Amalfi/Venezia 2



CARATTERISTICHE TECNICHE
TECHNICAL CHARACTERISTICS

- Tubo Ø25x1,5 mm di spessore.
 - Speciale verniciatura in polvere epossidica antigraffio.
 - Rivestimento in laminato stratificato di grande spessore.
 - Venezia 1 Kg 61
 - Venezia 2 Kg 64
- *Square tube Ø25x1,5 mm thick.*
 - *Special coating with scratchproof epoxy powder.*
 - *Thick laminate layers coating.*
 - *Venezia 1 Kg 61*
 - *Venezia 2 Kg 64*

Carrelli hotel
Chambermaid trolleys
Classic



AMALFI ELEGANCE 1
da 12 a 15 camere
from 12 to 15 rooms

Colori disponibili/
Colours available
90019
frassino (chiaro)/*ash (light)*
90020
noce (scuro)/*walnut (dark)*



AMALFI ELEGANCE 2
da 12 a 15 camere
from 12 to 15 rooms

Colori disponibili/
Colours available
90021
frassino (chiaro)/*ash (light)*
90022
noce (scuro)/*walnut (dark)*

Applicazioni

How to use



Aperto
Open



CARATTERISTICHE TECNICHE
TECHNICAL CHARACTERISTICS

- Tubo Ø25x1,5 mm di spessore.
- Speciale verniciatura in polvere epossidica antigraffio.
- Rivestimento in laminato stratificato di grande spessore.
- Amalfi Elegance 1 Kg 59
- Amalfi Elegance 2 Kg 62
- *Square tube Ø25x1,5 mm thick.*
- *Special coating with scratchproof epoxy powder.*
- *Thick laminate layers coating.*
- *Amalfi Elegance 1 Kg 59*
- *Amalfi Elegance 2 Kg 62*

Misure / Sizes

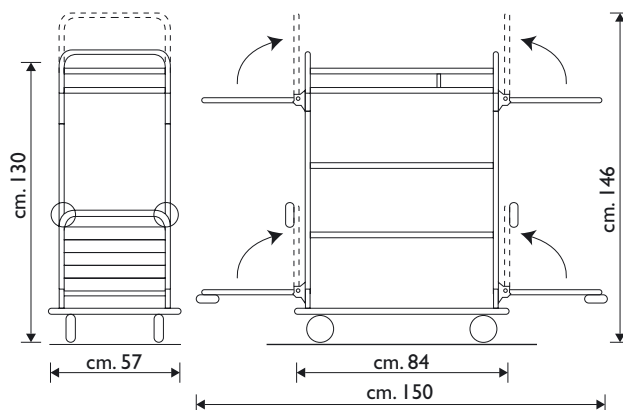

Carrelli hotel
Chambermaid trolleys
Classic



VENEZIA ELEGANCE 1 Colori disponibili/
da 15 a 18 camere *Colours available*
from 15 to 18 rooms 90023
frassino (chiaro)/*ash (light)*
90024
noce (scuro)/*walnut (dark)*



VENEZIA ELEGANCE 2 Colori disponibili/
da 15 a 18 camere *Colours available*
from 15 to 18 rooms 90025
frassino (chiaro)/*ash (light)*
90026
noce (scuro)/*walnut (dark)*

Misure / *Sizes*

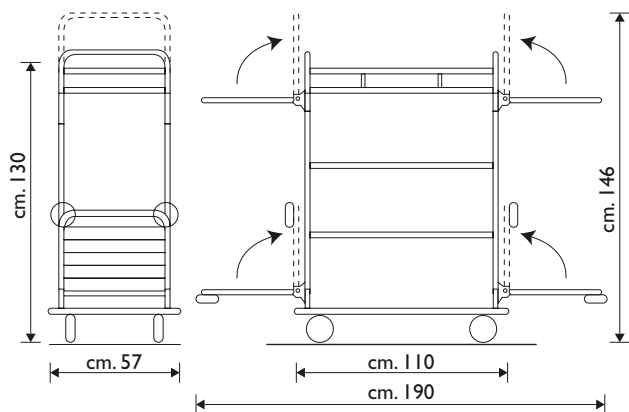

CARATTERISTICHE TECNICHE
TECHNICAL CHARACTERISTICS

- Tubo Ø25x1,5 mm di spessore.
- Speciale verniciatura in polvere epossidica antigraffio.
- Rivestimento in laminato stratificato di grande spessore.
- Amalfi Elegance 1 Kg 64
- Amalfi Elegance 2 Kg 67
- *Square tube Ø25x1,5 mm thick.*
- *Special coating with scratchproof epoxy powder.*
- *Thick laminate layers coating.*
- *Amalfi Elegance 1 Kg 64*
- *Amalfi Elegance 2 Kg 67*

Carrelli hotel
Chambermaid trolleys
Classic



AMALFI CATERING

Colori disponibili/
Colours available
90027
frassino (chiaro)/*ash (light)*
90028
noce (scuro)/*walnut (dark)*



VENEZIA CATERING

Colori disponibili/
Colours available
90029
frassino (chiaro)/*ash (light)*
90030
noce (scuro)/*walnut (dark)*

Applicazioni

How to use



In uso
In use



CARATTERISTICHE TECNICHE
TECHNICAL CHARACTERISTICS

- Tubo Ø25x1,5 mm di spessore.
- Speciale verniciatura in polvere epossidica antigraffio.
- Rivestimento in laminato stratificato di grande spessore.
- Amalfi Catering Kg 55
- Venezia Catering Kg 59
- *Square tube Ø25x1,5 mm thick.*
- *Special coating with scratchproof epoxy powder.*
- *Thick laminate layers coating.*
- *Amalfi Catering Kg 55*
- *Venezia Catering Kg 59*

Misure / *Sizes*

AMALFI CATERING

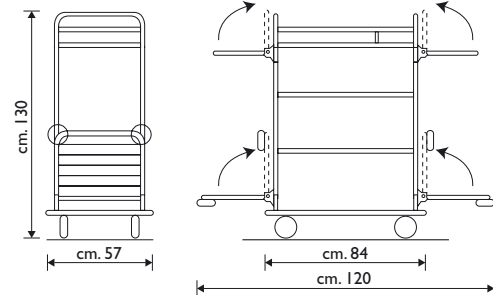

VENEZIA CATERING

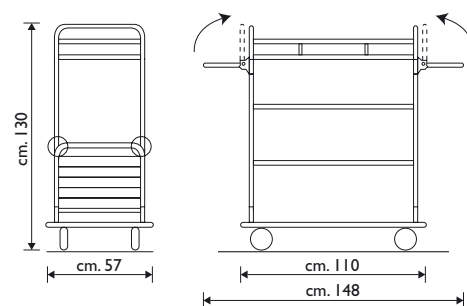

Carrelli hotel
Chambermaid trolleys
Classic



90035
AMALFI BAG

cm 85 x 57 x 185 h
kg 28 (vuoto - *empty*)



90036
VENEZIA BAG

cm 105 x 57 x 185 h
kg 28 (vuoto - *empty*)



90061 SET
Kit Portaborse
Bag holder kit



Amalfi Bag con kit portaborse e valigie
Amalfi Bag with Bag holder kit

Venezia Bag con valigie
Venezia Bag with luggages



Plastica e
Acciaio Rilsan
*Plastic and Rilsan
protected steel*

Linea Hotel Innovative *Innovative Hotel line*

Una gamma di carrelli costruita con materiali adatti all'uso esterno. Dimensioni e portate studiate per alberghi vacanze.

A line of trolleys made of materials suitable for outdoor use. Dimensions and capacities specifically studied for hotels and tourist resorts.



CAPRI 1 - 80001
da 8 a 10 camere
from 8 to 10 rooms

Misure/*Sizes*
110x55x152 h
20 Kg



CAPRI 1 - 80001/C
Chiuso/*Enclosed*
da 8 a 10 camere
from 8 to 10 rooms

Misure/*Sizes*
110x55x152 h
23,5 Kg



Piastre in alluminio regolabili in altezza
Height adjustable aluminium fixing plates



Applicazioni

How to use



Ruota morbida Ø 150 mm per esterni
Outdoor soft castor (Ø150 mm)

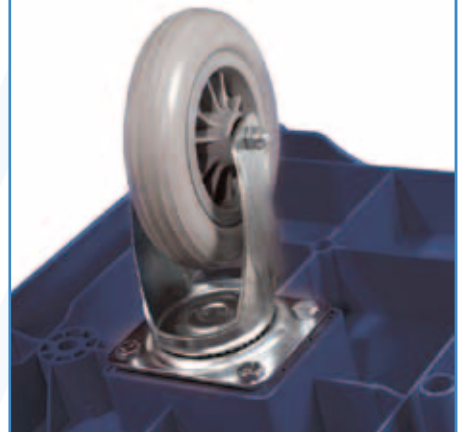

CARATTERISTICHE TECNICHE
TECHNICAL CHARACTERISTICS

- Tubo Ø22x1,5 mm di spessore.
- Rivestimento in Rilsan.
- Sacchi in nylon.
- Ruote ø125 con 4 punti di attacco.
- Base-ripiani-cassetti in polipropilene copolimero.
- *Square tube Ø22x1,5 mm thick.*
- *Rilsan coating.*
- *Nylon bags.*
- *Castors ø125 with 4 fixing points.*
- *Copolymer polypropylene base, shelves, drawers.*

Carrelli hotel
Chambermaid trolleys
Innovative



VDM
CAPRI 2 - 80002
 da 8 a 12 camere
from 8 to 12
rooms

Misure/*Sizes*
 150/110x55x152 h
 22 Kg



VDM
CAPRI 2 - 80002/C
 Chiuso/*Enclosed*
 da 8 a 12 camere
from 8 to 12 rooms

Misure/*Sizes*
 150/110x55x152 h
 25,5 Kg

Applicazioni

How to use



Ruota morbida Ø 150 mm per esterni
Outdoor soft castor (Ø150 mm)

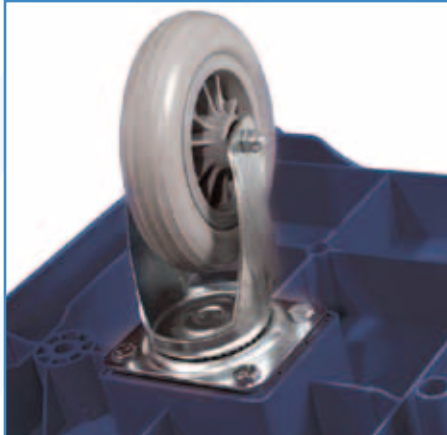

Pratica impugnatura
Practical handle



CARATTERISTICHE TECNICHE
TECHNICAL CHARACTERISTICS

- Tubo Ø22x1,5 mm di spessore.
- Rivestimento in Rilsan.
- Sacchi in nylon.
- Ruote ø125 con 4 punti di attacco.
- Base-ripiani-cassetti in polipropilene copolimero.
- *Square tube Ø22x1,5 mm thick.*
- *Rilsan coating.*
- *Nylon bags.*
- *Castors ø125 with 4 fixing points.*
- *Copolymer polypropylene base, shelves, drawers.*

Carrelli hotel
Chambermaid trolleys
 Innovative



CAPRI 3 - 80003
da 8 a 12 camere
from 8 to 12 rooms

Misure/Sizes
140x55x152 h
24 Kg



CAPRI 3 - 80003/C
Chiuso/*Enclosed*
da 8 a 12 camere
from 8 to 12 rooms

Misure/Sizes
140x55x152 h
28 Kg



Applicazioni

How to use



Ruota morbida Ø 150 mm per esterni
Outdoor soft castor (Ø150 mm)

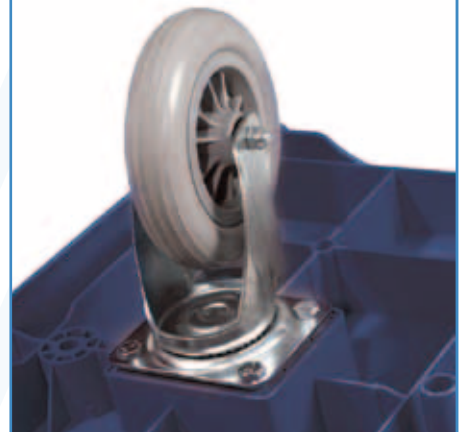

CARATTERISTICHE TECNICHE
TECHNICAL CHARACTERISTICS

- Tubo Ø22x1,5 mm di spessore.
- Rivestimento in Rilsan.
- Sacchi in nylon.
- Ruote ø125 con 4 punti di attacco.
- Base-ripiani-cassetti in polipropilene copolimero.
- *Square tube Ø22x1,5 mm thick.*
- *Rilsan coating.*
- *Nylon bags.*
- *Castors ø125 with 4 fixing points.*
- *Copolymer polypropylene base, shelves, drawers.*

Carrelli hotel

Chambermaid trolleys

Innovative



CAPRI 4 - 80004
da 8 a 10 camere
from 8 to 10 rooms

Misure/*Sizes*
140 x 55 x 152 h
36 Kg



CAPRI 5 - 80005
da 8 a 10 camere
from 8 to 10 rooms

Misure/*Sizes*
140 x 55 x 152 h
35 Kg

Applicazioni

How to use



Ruota morbida Ø 150 mm per esterni
Outdoor soft castor (Ø150 mm)

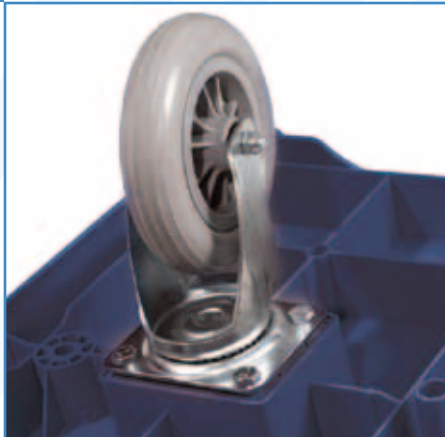

CARATTERISTICHE TECNICHE
TECHNICAL CHARACTERISTICS

- Tubo Ø22x1,5 mm di spessore.
- Rivestimento in Rilsan.
- Sacchi in nylon.
- Ruote ø125 con 4 punti di attacco.
- Base-ripiani-cassetti in polipropilene copolimero.
- *Square tube Ø22x1,5 mm thick.*
- *Rilsan coating.*
- *Nylon bags.*
- *Castors ø125 with 4 fixing points.*
- *Copolymer polypropylene base, shelves, drawers.*



Carrelli hotel
Chambermaid trolleys
Innovative



CAPRI 6 - 80006
da 8 a 10 camere
from 8 to 10 rooms
Misure/*Sizes*
140 x 55 x 152 h
33 Kg



CAPRI 7 - 80007
da 8 a 12 camere
from 8 to 12 rooms
Misure/*Sizes*
160/110 x 55 x 152 h
38 Kg



Applicazioni

How to use



Ruota morbida Ø 150 mm per esterni
Outdoor soft castor (Ø150 mm)

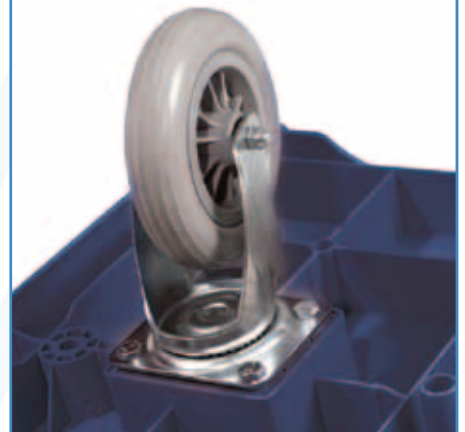

CARATTERISTICHE TECNICHE
TECHNICAL CHARACTERISTICS

- Tubo Ø22x1,5 mm di spessore.
- Rivestimento in Rilsan.
- Sacchi in nylon.
- Ruote ø125 con 4 punti di attacco.
- Base-ripiani-cassetti in polipropilene copolimero.
- *Square tube Ø22x1,5 mm thick.*
- *Rilsan coating.*
- *Nylon bags.*
- *Castors ø125 with 4 fixing points.*
- *Copolymer polypropylene base, shelves, drawers.*

Carrelli hotel
Chambermaid trolleys
Innovative



ISCHIA 11 - 80011
da 12 a 15 camere
from 12 to 15 rooms

Misure/*Sizes*
150/110x55x152 h
25 Kg



ISCHIA 11 - 80011/C Misure/*Sizes*
Chiuso/*Enclosed* 150/110x55x152 h
da 12 a 15 camere 29,5 Kg
from 12 to 15 rooms

Applicazioni

How to use



Ruota morbida Ø 150 mm per esterni
Outdoor soft castor (Ø150 mm)

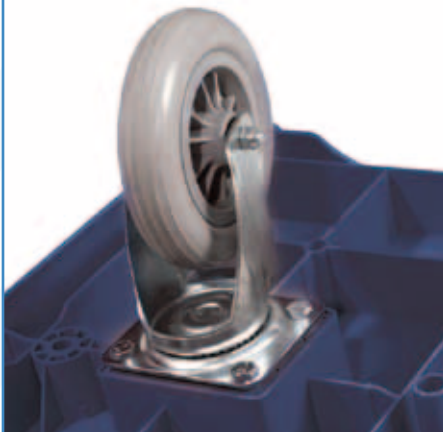

Apertura cassetto
Drawer opening

CARATTERISTICHE TECNICHE
TECHNICAL CHARACTERISTICS

- Tubo Ø22x1,5 mm di spessore.
- Rivestimento in Rilsan.
- Sacchi in nylon.
- Ruote ø125 con 4 punti di attacco.
- Base-ripiani-cassetti in polipropilene copolimero.
- *Square tube Ø22x1,5 mm thick.*
- *Rilsan coating.*
- *Nylon bags.*
- *Castors ø125 with 4 fixing points.*
- *Copolymer polypropylene base, shelves, drawers.*

Carrelli hotel
Chambermaid trolleys
Innovative



ISCHIA 12 - 80012 *Misure/Sizes*
da 15 a 18 camere 190/110x55x152 h
from 15 to 18 rooms 26 Kg



ISCHIA 12 -80012/C *Misure/Sizes*
Chiuso/Enclosed 190/110x55x152 h
da 15 a 18 camere 30 Kg
from 15 to 18 rooms

Ad ogni ripiano può essere applicato un cassetto
Possibility to apply a drawer to each shelf



Applicazioni

How to use



Ruota morbida Ø 150 mm per esterni
Outdoor soft castor (Ø150 mm)

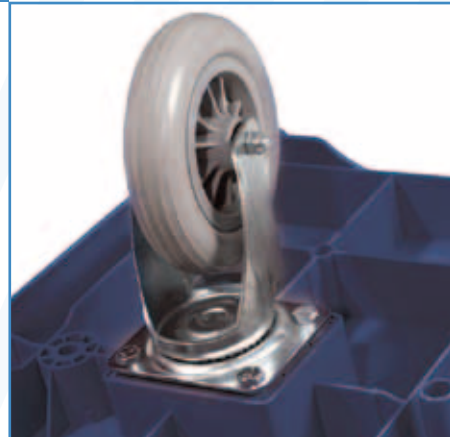

CARATTERISTICHE TECNICHE
TECHNICAL CHARACTERISTICS

- Tubo Ø22x1,5 mm di spessore.
- Rivestimento in Rilsan.
- Sacchi in nylon.
- Ruote ø125 con 4 punti di attacco.
- Base-ripiani-cassetti in polipropilene copolimero.
- *Square tube Ø22x1,5 mm thick.*
- *Rilsan coating.*
- *Nylon bags.*
- *Castors ø125 with 4 fixing points.*
- *Copolymer polypropylene base, shelves, drawers.*

Carrelli hotel
Chambermaid trolleys
Innovative



ISCHIA 13 - 80013
da 15 a 18 camere
from 15 to 18 rooms

Misure/*Sizes*
190/150x55x152 h
28 Kg



ISCHIA 13 - 80013/C Misure/*Sizes*
Chiuso/*Enclosed*
da 15 a 18 camere
from 15 to 18 rooms

190/150x55x152 h
32,5 Kg

Applicazioni

How to use



Ruota morbida Ø 150 mm per esterni
Outdoor soft castor (Ø150 mm)

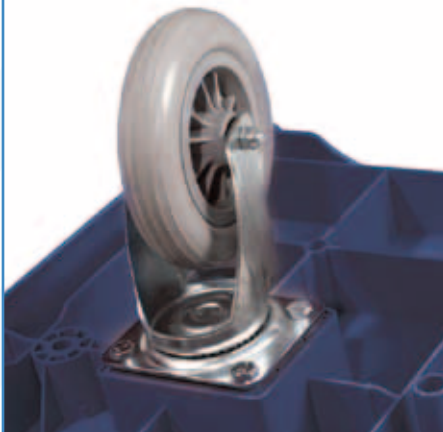

Cappuccio impermeabile con tenda per la protezione dalla pioggia
Waterproof hood and cover



CARATTERISTICHE TECNICHE
TECHNICAL CHARACTERISTICS

- Tubo Ø22x1,5 mm di spessore.
- Rivestimento in Rilsan.
- Sacchi in nylon.
- Ruote ø125 con 4 punti di attacco.
- Base-ripiani-cassetti in polipropilene copolimero.
- *Square tube Ø22x1,5 mm thick.*
- *Rilsan coating.*
- *Nylon bags.*
- *Castors ø125 with 4 fixing points.*
- *Copolymer polypropylene base, shelves, drawers.*

Carrelli hotel
Chambermaid trolleys
Innovative



ISCHIA 15 - 80015 Misure/*Sizes*
da 15 a 18 camere 190x55x152 h
from 15 to 18 rooms 32 Kg



ISCHIA 15 - 80015/C Misure/*Sizes*
Chiuso/*Enclosed* 190x55x152 h
da 15 a 18 camere 36 Kg
from 15 to 18 rooms



Modello Ischia con sistema di lavaggio trasportato (e mobile)
"Ischia" model including mobile mopping system (removable)

Applicazioni

How to use



Ruota morbida Ø 150 mm per esterni
Outdoor soft castor (Ø150 mm)

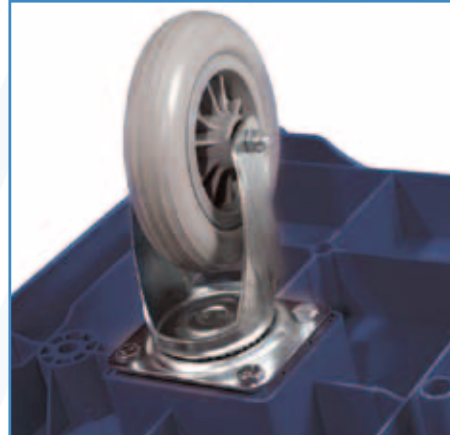

CARATTERISTICHE TECNICHE
TECHNICAL CHARACTERISTICS

- Tubo Ø22x1,5 mm di spessore.
- Rivestimento in Rilsan.
- Sacchi in nylon.
- Ruote ø125 con 4 punti di attacco.
- Base-ripiani-cassetti in polipropilene copolimero.
- *Square tube Ø22x1,5 mm thick.*
- *Rilsan coating.*
- *Nylon bags.*
- *Castors ø125 with 4 fixing points.*
- *Copolymer polypropylene base, shelves, drawers.*

Carrelli hotel
Chambermaid trolleys
Innovative



LINOSA 1 - 80016

Misure/*Sizes*
cm 110x55x113 h (350 lt.)



LINOSA 2 - 80018

Misure/*Sizes*
cm 110x55x152 h

Applicazioni

How to use



Ruota morbida Ø 150 mm per esterni
Outdoor soft castor (Ø150 mm)

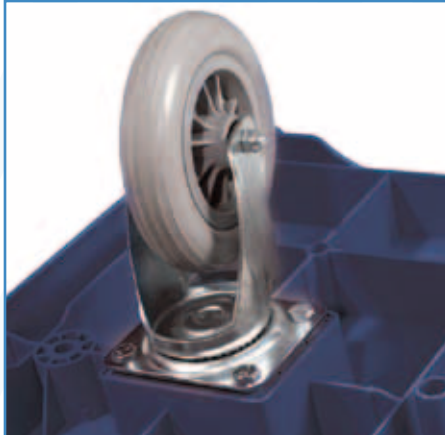

CARATTERISTICHE TECNICHE
TECHNICAL CHARACTERISTICS

- Tubo Ø22x1,5 mm di spessore.
- Rivestimento in Rilsan.
- Sacchi in nylon.
- Ruote ø125 con 4 punti di attacco.
- Base-ripiani-cassetti in polipropilene copolimero.
- *Square tube Ø22x1,5 mm thick.*
- *Rilsan coating.*
- *Nylon bags.*
- *Castors ø125 with 4 fixing points.*
- *Copolymer polypropylene base, shelves, drawers.*



Sacchi in nylon da 150 lt. con profili colorati. Con chiusura a scatto e maniglie di trasporto.
Nylon bags (150 lt.) with coloured profiles, click closing system and carrying handles.

Carrelli hotel
Chambermaid trolleys
Innovative



Per raccolta rifiuti
For waste collection



LINOSA 3 - 80019

Misure/*Sizes*
 140/110x55x152 cm



LINOSA 4 - 80020

Misure/*Sizes*
 190/140x55x152 cm

Applicazioni

How to use



Estensione per
 raccolta differenziata

Extension for waste collection

80085 SET
 Estensione
 per raccolta
 differenziata
 Capri/Ischia

*Extension for
 waste collection
 Capri/Ischia*



Applicazioni

How to use



Ruota morbida Ø 150 mm per esterni
Outdoor soft castor (Ø150 mm)

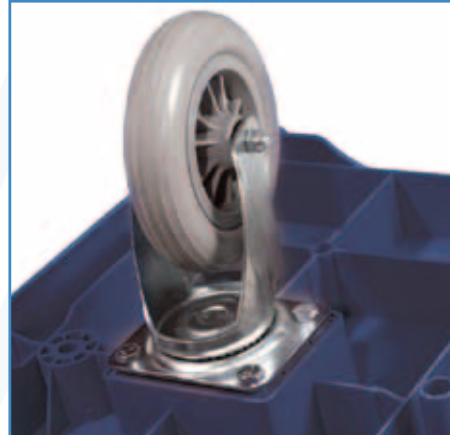

CARATTERISTICHE TECNICHE
TECHNICAL CHARACTERISTICS

- Tubo Ø22x1,5 mm di spessore.
- Rivestimento in Rilsan.
- Sacchi in nylon.
- Ruote ø125 con 4 punti di attacco.
- Base-ripiani-cassetti in polipropilene copolimero.
- *Square tube Ø22x1,5 mm thick.*
- *Rilsan coating.*
- *Nylon bags.*
- *Castors ø125 with 4 fixing points.*
- *Copolymer polypropylene base, shelves, drawers.*

Carrelli hotel
Chambermaid trolleys

Innovative



Carrelli hotel
Chambermaid trolleys
Innovative



ELBA

Y.C.F.



ELBA 1 - 80022

Misure/Sizes
125 X 44 X 105 h cm



ELBA 2 - 80023

Misure/Sizes
140 X 44 X 105 h cm



ELBA 3 - 80024

Misure/Sizes
125 X 44 X 105 h cm



ELBA 4 - 80017

Misure/Sizes
53 X 50 X 104 h cm

CARATTERISTICHE TECNICHE

- Tubo di acciaio cromato Ø22x1,5 mm di spessore.
- Sacchi di tela sanforizzata.
- Ruote Ø100 mm.
- Coperchio con aggancio.

TECHNICAL CHARACTERISTICS

- Chromium plated steel tube Ø22 (thickness: 1,5 mm).
- Sanforized cotton bags.
- Castors Ø100 mm.
- Catch on lid.

**Carrelli hotel
Chambermaid trolleys**

Elba





Ed. 02 04/2011

PREZZO/PRICE € 5,00

CLEANING

SANITÀ - HEALTH

HOTEL



Viale delle Industrie, 16
20020, Arese, (MI) - Italy
Tel. +39 02 93 58 10 11
Tel. +39 02 93 80 501
Fax +39 02 93 80 693
email: vdm@vdm.it
<http://www.vdm.it>

